

JACK

HEAD

IDENTIFICATION

TEXACONE CYLINDER HEAD IDENTIFICATION SYSTEM

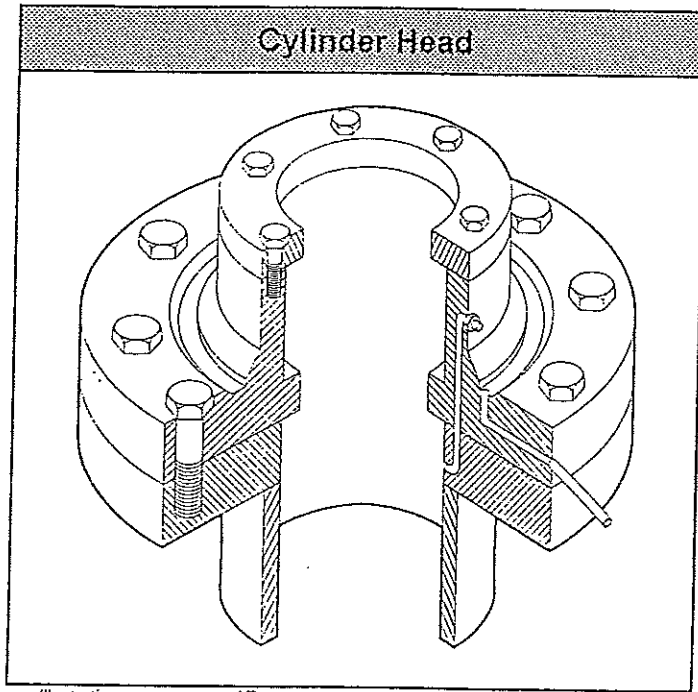
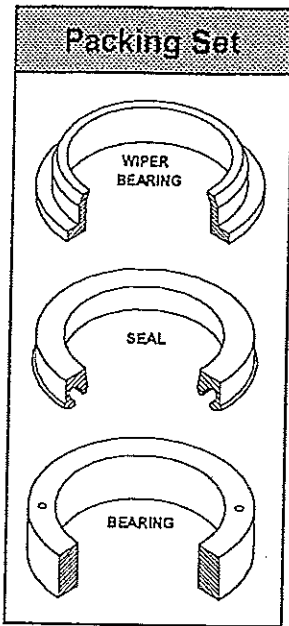

**American Crescent
Commercial**

Plunger Size	Packing Set Number	Replacement Seal Number
3-1/2	6EA109-06	8E004
4-1/2	6EA109-07	8E019
5	6EA109-08	8E024
5-1/2	6EA109-09	8E025
6	6EA109-10	8E027
6-1/2	6EA109-11	8E008

Note: Last two sizes have an additional seal and lantern ring.

AM. CRESCENT COMM.

TEXACONE CYLINDER HEAD IDENTIFICATION SYSTEM

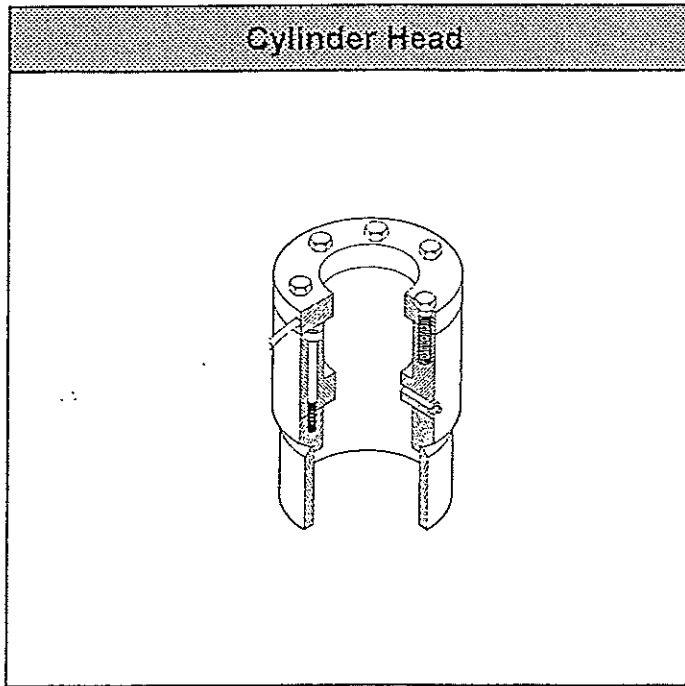
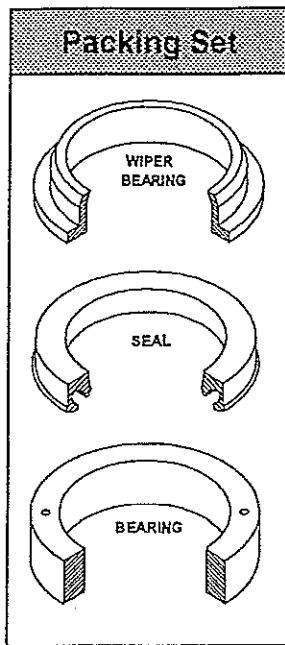

Illustrations are property of Texacone and may not be reproduced without permission.

**American Crescent
Residential - Holeless**

Plunger Size	Packing Set Number	Replacement Seal Number
2-1/2	6EA109-01	8E053
2-7/8	6EA109-02	8E057
3	6EA109-05	8E021
3-1/8	6EA109-03	8E044
3-1/2	6EA109-06	8E004
3-7/8	6EA109-04	8E001

© 1998 THE TEXACONE COMPANY, INC.

TEXACONE®

800.235.2727 FAX 972.289.6285
www.texacone.com

AMERICAN CRESCENT HOLELESS

TEXACONE CYLINDER HEAD IDENTIFICATION SYSTEM

AMTECH

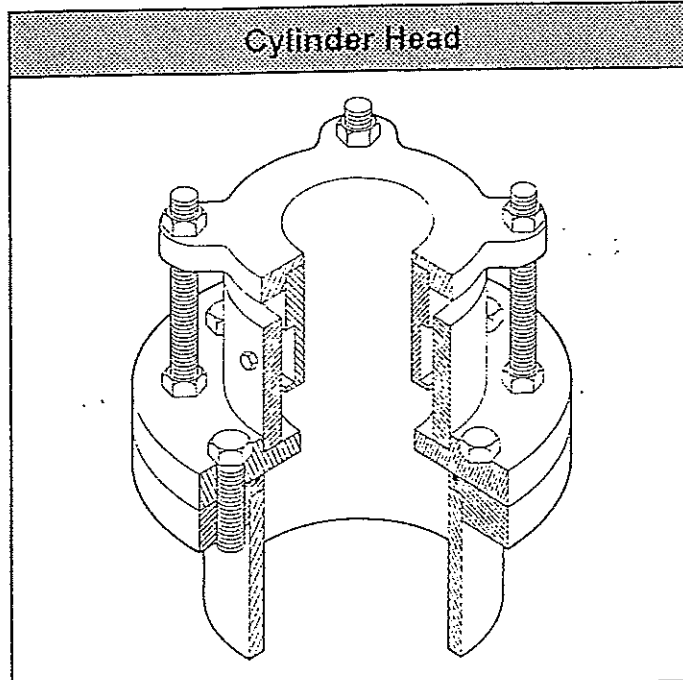
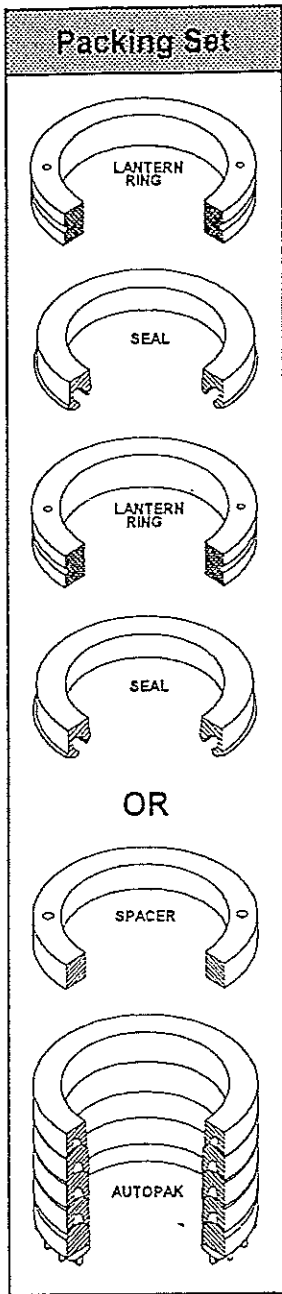

Illustrations are property of Texacone and may not be reproduced without permission.

Amtech

Plunger Size	Packing Set Number	Replacement Seal Number	Autopak Set Number
3-7/8	6EA116-06	8E001	1A104-09
4	6EA116-01	8E058	1A104-10
4-3/8	6EA116-07	8E007	1A104-01
4-1/2	6EA116-02	8E050	1A104-02
5	6EA116-03	8E051	1A104-03
5-7/16	6EA116-08	8E023	1A104-04
5-1/2	6EA116-04	8E056	1A104-05
6	6EA116-09	8E036	1A104-06
6-1/2	6EA116-05	8E026	1A104-07
7	6EA116-10	8E035	1A104-08

Split Packing Set, 6EA107-xx is available in most sizes.
 Several other set configurations still available.

6EA116-10 6E035

© 1998 THE TEXACONE COMPANY, INC.

TEXACONE®

800.235.2727 FAX 972.289.6285
 www.texacone.com

TEXACONE CYLINDER HEAD IDENTIFICATION SYSTEM

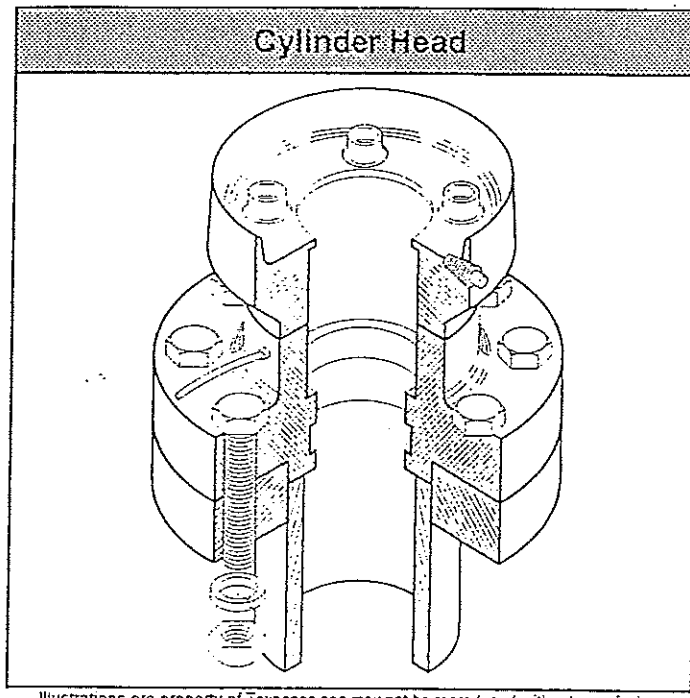
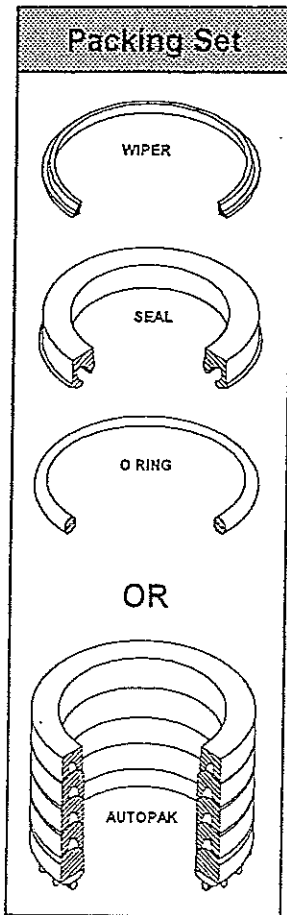

ARMOR

Armor

Plunger Size	Packing Set Number	Replacement Seal Number	Autopak Set Number
3	2EA003-23	6E126	-
3-1/2	2EA003-24	6E001	-
4	2EA003-26	6E005	1A091-11
4-1/4	2EA003-17	6E033	1A091-09
4-7/16	2EA003-01	6E032	1A091-01
4-1/2	2EA003-25	6E161SF	-
5	2EA003-18	6E020	1A091-10
5-1/2	2EA003-02	6E221SF	1A091-02
6	2EA003-19	6E028	1A091-12
6-9/16	2EA003-03	6E031	1A091-03
7-9/16	2EA003-04	6E059	1A091-04
8-9/16	2EA003-05	6E064	1A091-05
9-9/16	2EA003-06	2E007	1A091-06
10-11/16	2EA003-07	6E069	1A091-07
12-11/16	2EA003-08	6E068	1A091-08

In Canada - "Schindler", In USA - "Kone"
Lantern Rings available for both 1/2" and 3/4" cross sections.

© 1998 THE TEXACONE COMPANY, INC.

TEXACONE CYLINDER HEAD IDENTIFICATION SYSTEM

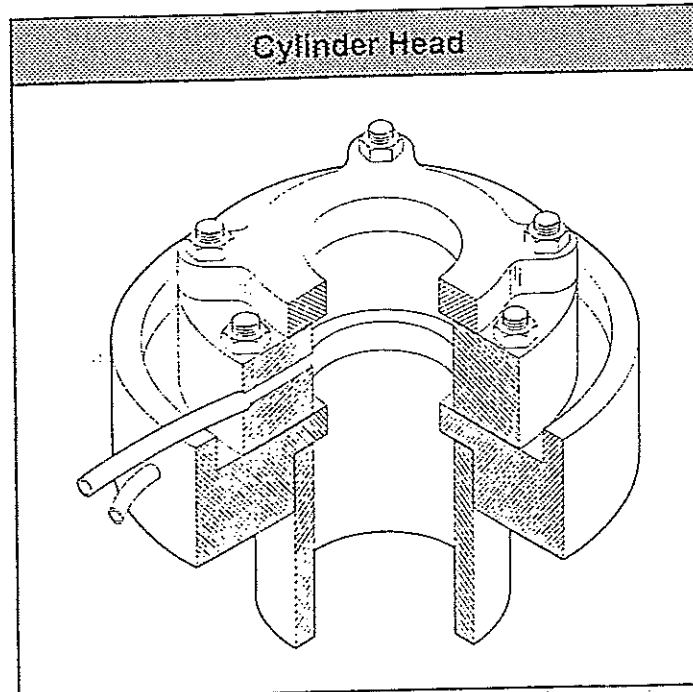
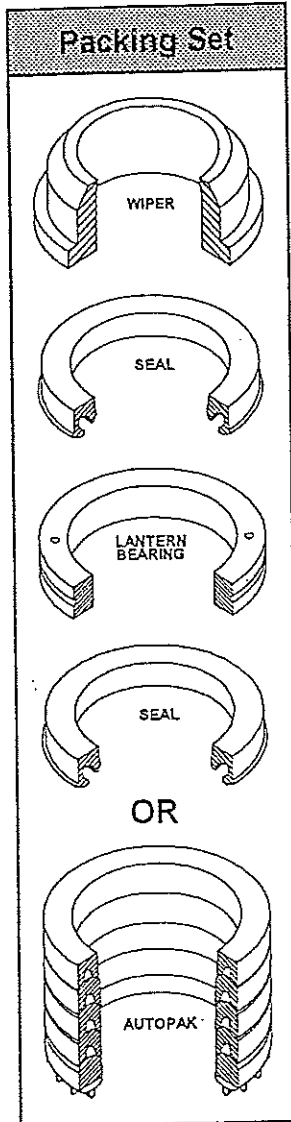

Illustrations are property of Texacone and may not be reproduced without permission.

BORE - MAX

Bore - Max

Plunger Size	Packing Set Number	Replacement Seal Number	Autopak Set Number
2-1/2	6EA006-01	3E005	1A083-01
3	6EA006-19	6E227SF	1A083-19
3-1/2	6EA006-02	6E001	1A083-02
3-7/8	6EA006-20	8E001	1A083-20
4	6EA006-15	8E058	1A083-15
4-3/8	6EA006-03	8E007	1A083-03
5	6EA006-04	8E051	1A083-04
5-7/16	6EA006-05	8E023	1A083-05
5-1/2	6EA006-06	8E056	1A083-06
6	6EA006-14	8E036	1A083-14
6-1/2	6EA006-07	8E026	1A083-07
6-9/16	6EA006-08	6E031	1A083-08
7	6EA006-09	6E035	1A083-09
7-1/2	6EA006-10	8E037	1A083-10
8	6EA006-16	6E037	1A083-16
8-1/2	6EA006-11	6E030	1A083-11
9	6EA006-17	3E079	1A083-17
9-1/2	6EA006-12	6E039	1A083-12
10	6EA006-18	3E115	1A083-18
10-5/8	6EA006-13	6E042	1A083-13

Use the existing lantern bearing with Autopak Set.

© 1998 THE TEXACONE COMPANY, INC.

TEXACONE CYLINDER HEAD IDENTIFICATION SYSTEM

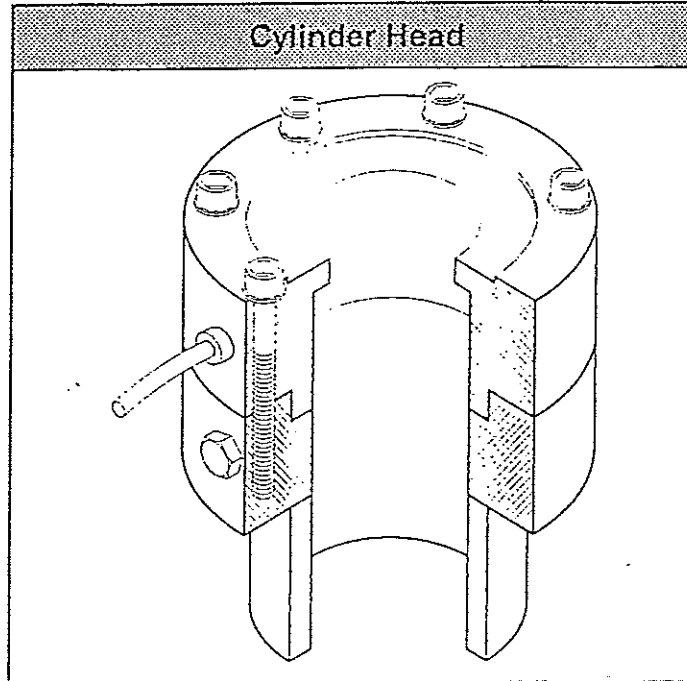
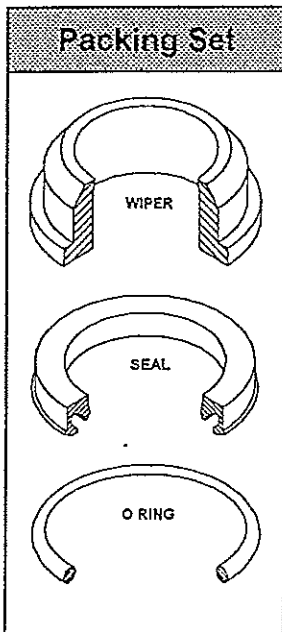

Illustrations are property of Texacone and may not be reproduced without permission.

CANTON

Canton

Plunger Size	Packing Set Number	Replacement Seal Number
3	6EA015-01	8E021
3-1/2	6EA015-02	6E001
4	6EA015-03	6E005
4-1/2	6EA015-04	6E161SF
5	6EA015-05	6E020
5-1/2	6EA015-06	6E221SF
6	6EA015-07	6E028
6-1/2	6EA015-08	6E208SF
6-9/16	6EA015-09	6E031
7	6EA015-10	6E035
7-1/2	6EA015-11	6E029
8	6EA015-12	6E037
8-1/2	6EA015-13	6E030
8-9/16	6EA015-14	6E064
9	6EA015-15	3E079
9-1/2	6EA015-16	6E039
10	6EA015-17	3E115
10-1/2	6EA015-18	6E141

© 1998 THE TEXACONE COMPANY, INC.

TEXACONE®

800.235.2727 FAX 972.289.6285
www.texacone.com

TEXACONE CYLINDER HEAD IDENTIFICATION SYSTEM

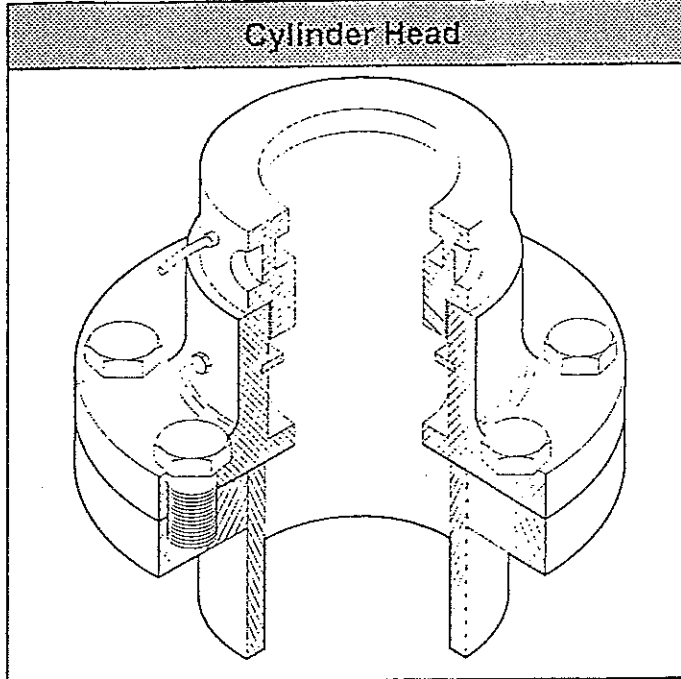
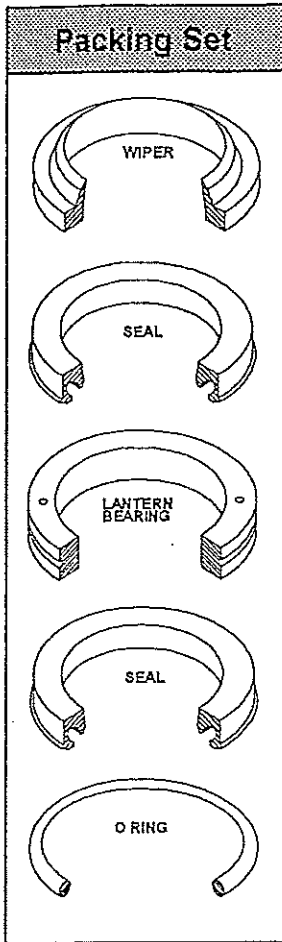

Illustrations are property of Texacone and may not be reproduced without permission.

CEMCO - FLANGE

**Cemco
Flange - Screw on**

Plunger Size	Packing Set Number	Replacement Seal Number*
3-7/16	6EA019-11	8E030 / 6E163SF
3-1/2	6EA019-01	6E118
3-3/4	6EA019-02	6E119
3-7/8	6EA019-24	8E078 / 6E164SF
4	6EA019-03	6E165SF
4-3/8	6EA019-12	6E166SF
4-7/16	6EA019-13	6E167SF
4-1/2	6EA019-04	8E019 / 6E168SF
5	6EA019-05	8E024 / 6E169SF
5-7/16	6EA019-14	6E170SF
5-1/2	6EA019-06	8E025 / 6E171SF
6	6EA019-07	8E027 / 6E172SF
6-1/2	6EA019-08	8E008 / 6E173SF
7	6EA019-09	8E090 / 6E174SF
7-1/2	6EA019-15	8E069 / 6E175SF
8	6EA019-16	8E104 / 6E176SF
8-1/2	6EA019-10	6E177SF
9	6EA019-17***	3E239
9-1/2	6EA019-18	6E179SF
10**	6EA019-19	6E180SF
10-1/2**	6EA019-20***	6E181SF
10-5/8	6EA019-21	6E115
12-1/2**	6EA019-22***	6E183SF
12-5/8**	6EA019-23	6E184SF

*Sets are provided as Reduced-Friction Sets. Specify reduced friction when ordering replacement seals as both seals listed are required.

Available by special order only *No wiper available.

© 1998 THE TEXACONE COMPANY, INC.

TEXACONE®

800.235.2727 FAX 972.289.6285
www.texacone.com

TEXACONE CYLINDER HEAD IDENTIFICATION SYSTEM

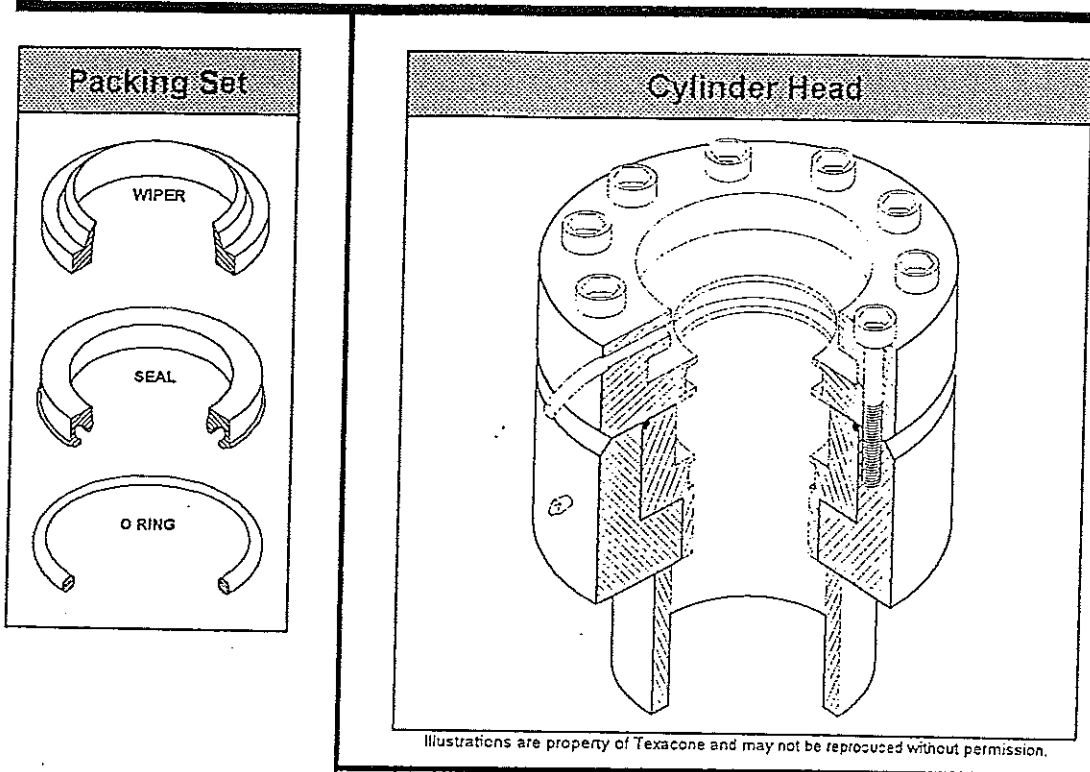

Illustrations are property of Texacone and may not be reproduced without permission.

CEMCO - WELDED

Cemco Welded		
Plunger Size	Packing Set Number	Replacement Seal Number
70mm (2-3/4)	6EA106-08*	8E003
100mm(3.93)	6EA106-02	8E032
120mm(4.72)	6EA106-07	8E063
3-7/16	6EA106-01*	8E030
4-1/2	6EA106-03	8E019
5	6EA106-04	8E024
5-1/2	6EA106-05	8E025
6-1/2	6EA106-06	8E008
6	6EA106-09	8E027
7	6EA106-10	8E090
7-1/2	6EA106-11	8E069

*These sets include 2 wear rings.
All dimensions in inches unless otherwise stated.

© 1998 THE TEXACONE COMPANY, INC.

TEXACONE CYLINDER HEAD IDENTIFICATION SYSTEM

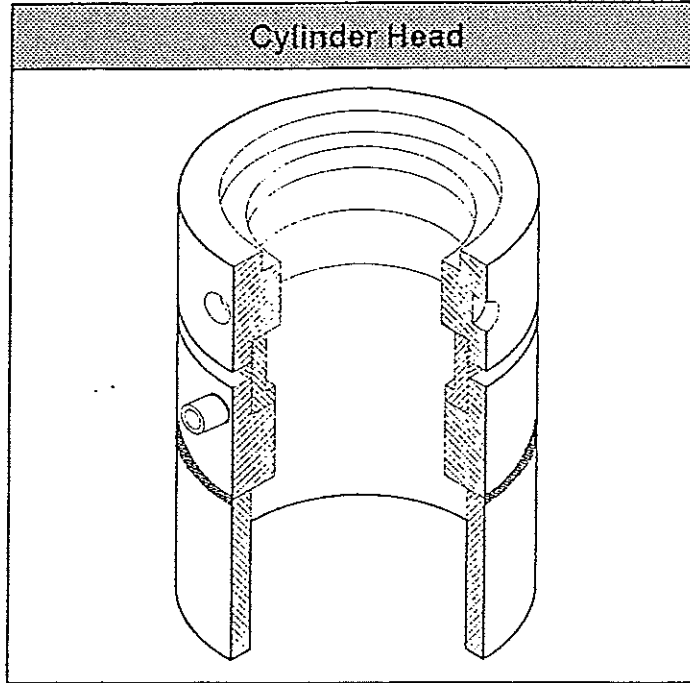
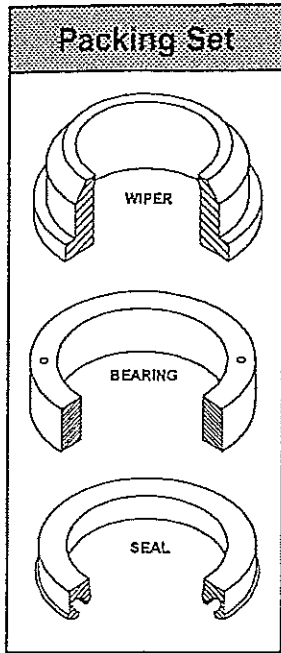

Illustrations are property of Texacone and may not be reproduced without permission.

Coast (CA)		
Plunger Size	Packing Set Number	Replacement Seal Number
4	6 EA 035-01	6E005
4-3/8	6 EA 035-02	6E206SF
5	6 EA 035-03	6E020
5-7/16	6 EA 035-04	6E219SF
5-1/2	6 EA 035-05	6E221SF
6	6 EA 035-06	6E028
6-7/16	6 EA 035-07	6E070
6-1/2	6 EA 035-08	6E208SF
7	6 EA 035-09	6E035
7-1/2	6 EA 035-10	6E029
8	6 EA 035-11	6E037
8-1/2	6 EA 035-12	6E030
10	6 EA 035-13	3E115

© 1998 THE TEXACONE COMPANY, INC.

TEXACONE®

800.235.2727 FAX 972.289.6285
www.texacone.com

COAST

TEXACONE CYLINDER HEAD IDENTIFICATION SYSTEM

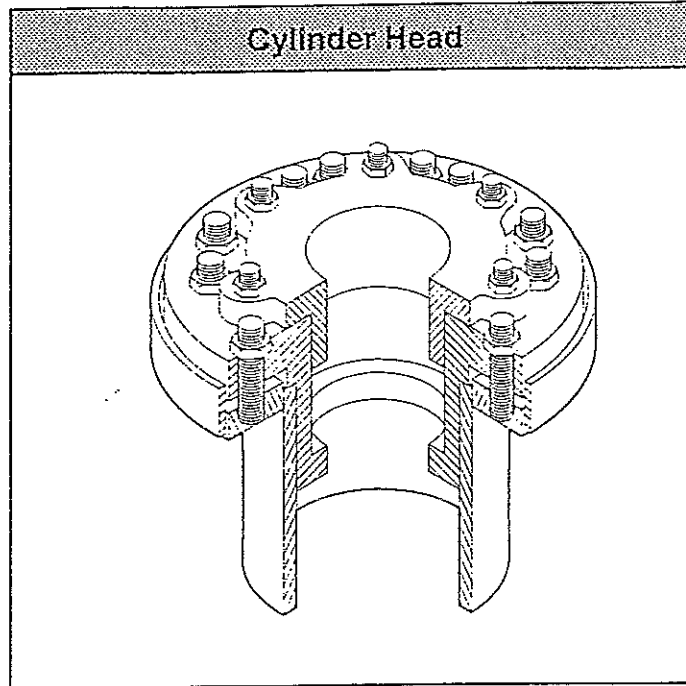
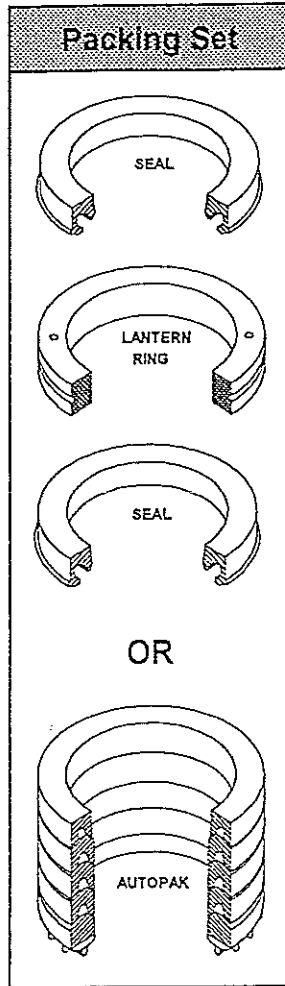

Illustrations are property of Texacone and may not be reproduced without permission.

Dover Rotary

Plunger Size	Packing Set Number	Replacement Seal Number	Autopak Set Number*
4-3/8**	3EA023-01	6E206SF	1A084-01
5-7/16**	3EA023-02	6E219SF	1A084-02
6-1/2**	3EA023-03	6E208SF	1A084-03
7-1/2(7S)	3EA023-04	6E029	1A084-04
8-1/2(8S)	3EA023-05	6E030	1A084-05
9-1/2(9S)	3EA023-06	6E039	1A084-06
10-5/8(10S)	3EA023-07	6E042	1A084-07
12-5/8(12S)	3EA023-08	6E041	1A084-08
15-3/4(15S)	3EA023-09	6E042	1A084-09

*Autopak is the recommended replacement packing.
 **Packing sets and seals are for Rotary Lifts manufactured prior to 1955. After 1955, see Dover-Rota.

3E042

DOVER - ROTARY

© 1998 THE TEXACONE COMPANY, INC.

TEXACONE CYLINDER HEAD IDENTIFICATION SYSTEM

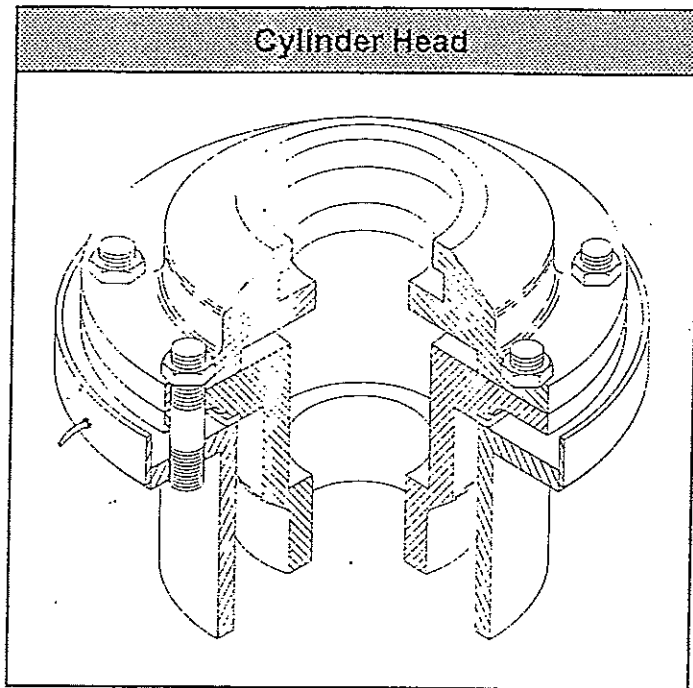
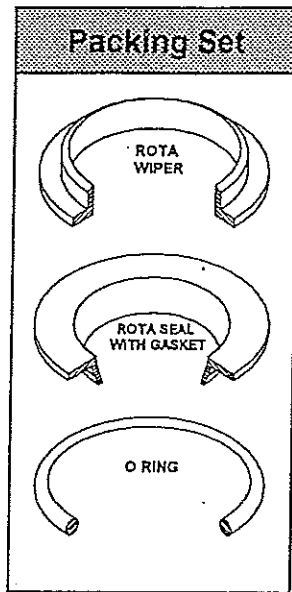

Illustrations are property of Texacone and may not be reproduced without permission.

Dover Rota

Plunger Size	Packing Set Number	Replacement Seal Number	Steel Spacer
3-1/2 (3S)	3EA023-11	4E002	-
4-3/8 (4S)	3EA023-12	4E003	-
5-7/16 (5S)	3EA023-13	4E004	-
6-1/2 (6S)	3EA023-14	4E005	-
7-1/2 (7S)	-	4E014	-
Undersized Plungers			
4-3/8 (4S)	3EA023-24	4E029	-
5-7/16 (5S)	3EA023-25	4E030	-
6-1/2 (6S)	3EA023-26	4E031	-
Older Two Seal Units (Use Standard Set Plus Steel Spacer)			
4-3/8 (4S)	3EA023-12	4E003	1S212
5-7/16 (5S)	3EA023-13	4E004	1S213
6-1/2 (6S)	3EA023-14	4E005	1S214

NOTE: Do not use two Rota Seals in tandem. Do not use standard 1/2 cross section seal below Rota Seal as this may result in excessive friction.

© 1999 THE TEXACONE COMPANY, INC.

TEXACONE®

800.235.2727 FAX 972.289.6285
www.texacone.com

TEXACONE CYLINDER HEAD IDENTIFICATION SYSTEM

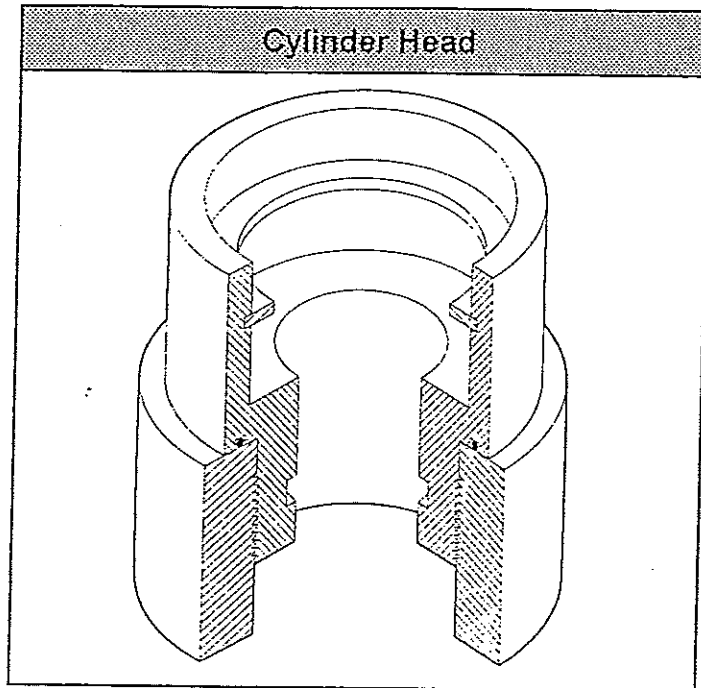
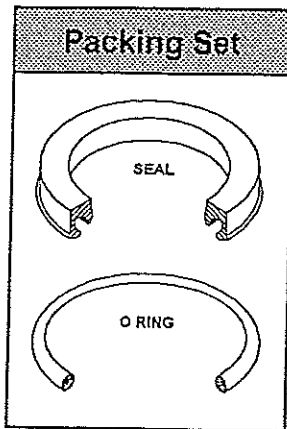

Illustrations are property of Texacone and may not be reproduced without permission.

Dover Holeless / Telescopic		
Plunger Size	Packing Set Number	Replacement Seal Number
3 Holeless	3EA023-27	8E074
2-1/2 Telescopic	3EA023-28	-
3 Telescopic	3EA023-29	-

Telescopic sets contain two seals and three o-rings.

DOVER HOLELESS / TELESCOPIC

© 1998 THE TEXACONE COMPANY, INC.

TEXACONE®

800.235.2727 FAX 972.289.6285
www.texacone.com

TEXACONE CYLINDER HEAD IDENTIFICATION SYSTEM

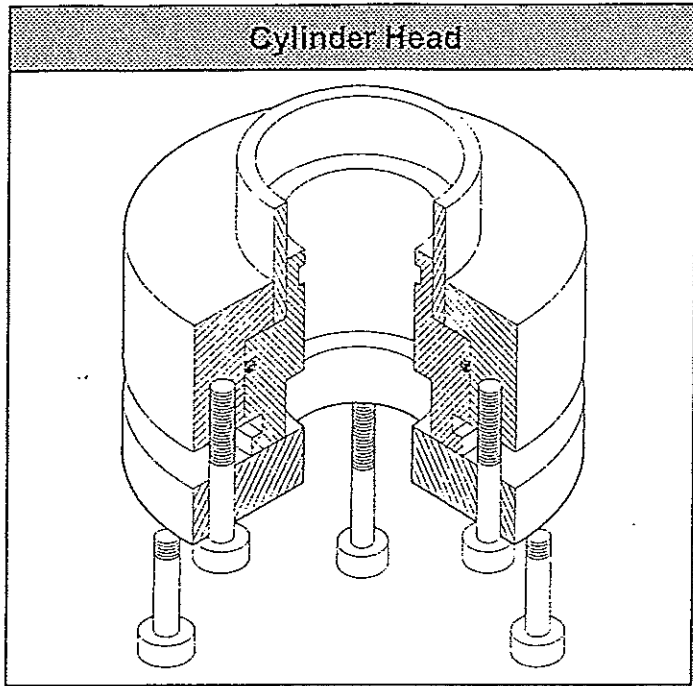
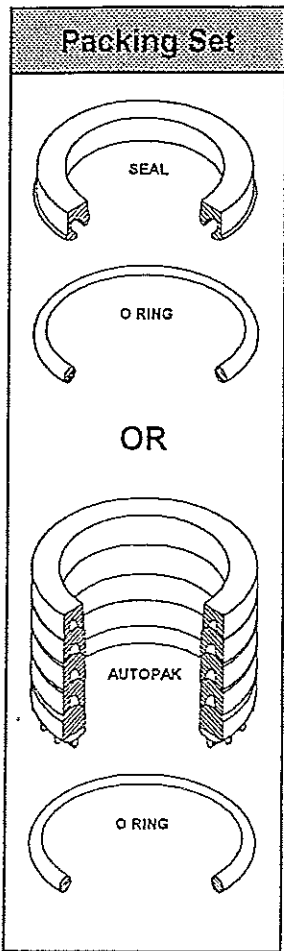

Illustrations are property of Texacone and may not be reproduced without permission.

**Dover
IVO**

Plunger Size	Packing Set Number	Replacement Seal Number	Autopak Set Number*
3-7/8	3EA023-21**	8E001	1A084-10

*Autopak is the recommended replacement packing.
** Split packing set, 3EA023-23, is also available.

DOVER - IVO

© 1998 THE TEXACONE COMPANY, INC.

TEXACONE CYLINDER HEAD IDENTIFICATION SYSTEM

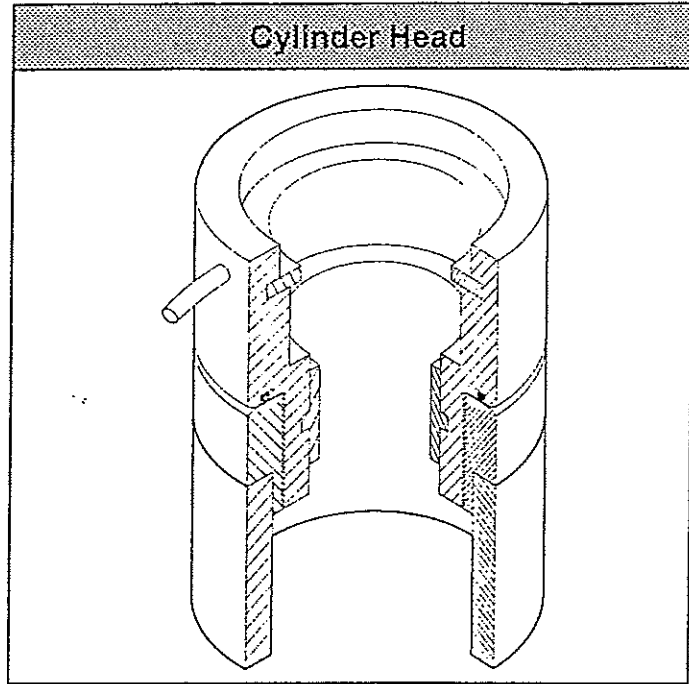
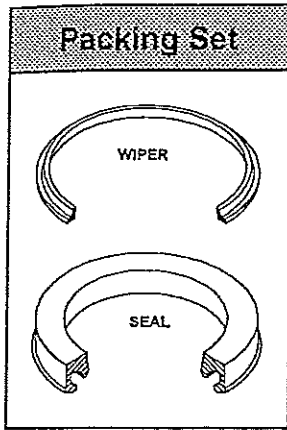

Illustrations are property of Texacone and may not be reproduced without permission.

Dover Cimarron		
Plunger Size	Packing Set Number	Replacement Seal Number
3-7/8	3EA023-22	8E078
Older units may not have wiper slot.		

DOVER - CIMARRON

© 1998 THE TEXACONE COMPANY, INC.

TEXACONE®

800.235.2727 FAX 972.289.6285
www.texacone.com

TEXACONE CYLINDER HEAD IDENTIFICATION SYSTEM

Packing Set

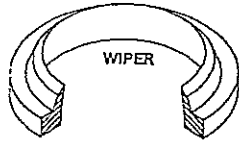

WIPER

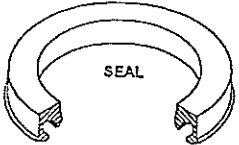

SEAL

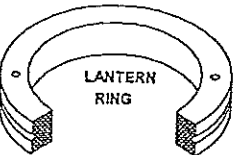

LANTERN RING

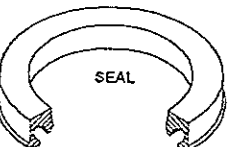

SEAL

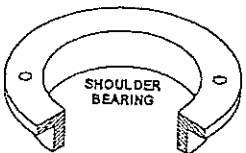

SHOULDER BEARING

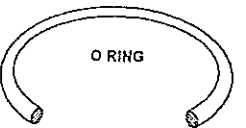

O RING

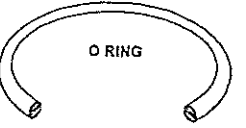

O RING

OR

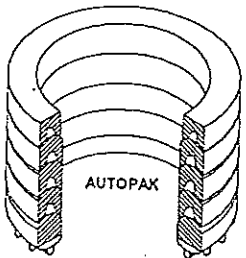

AUTOPAK

Cylinder Head

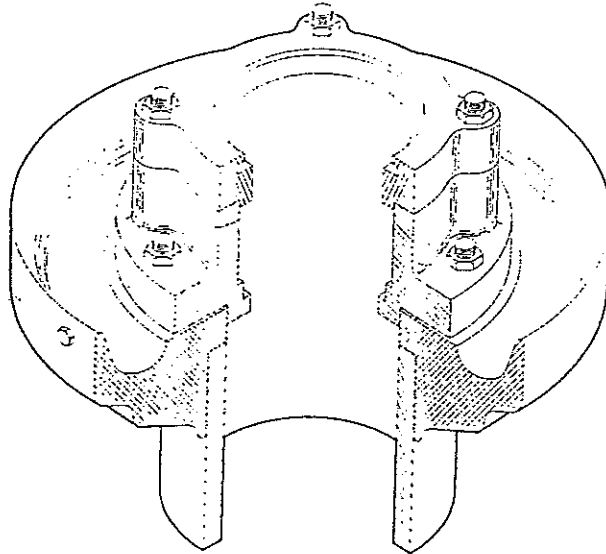

Illustrations are property of Texacone and may not be reproduced without permission.

ECCO CJ* & FJ

Plunger Size	Packing Set Number	Replacement Seal Number*	Autopak Set Number
2-3/4	6EA008-18	8E052/6E110SF	-
3-7/16	6EA008-10	6E040	1A089-10
3-1/2	6EA008-19	6E001	-
3-7/8	6EA008-11	8E001 / 6E205SF	1A089-11
4	6EA008-12	8E058 / 6E005	1A089-12
4-3/8	6EA008-01	8E007 / 6E206SF	1A089-01
5	6EA008-02	8E051 / 6E020	1A089-02
5-7/16	6EA008-03	8E023 / 6E219 SF	1A089-03
6	6EA008-04	8E036 / 6E028	1A089-04
6-1/2	6EA008-05	8E026 / 6E208 SF	1A089-05
7-1/2	6EA008-06	8E037 / 6E029	1A089-06
8-1/2	6EA008-07	6E030	1A089-07
10-5/8	6EA008-08	6E042	1A089-08
12-5/8	6EA008-09	6E041	1A089-09

*Note: CJ units were manufactured before 1965- uses one seal and one lantern ring.

**Sets are provided as Reduced-Friction Sets. Specify Reduced-Friction when ordering replacement seals as both seals are needed.

© 1998 THE TEXACONE COMPANY, INC.

TEXACONE®

800.235.2727 FAX 972.289.6285
www.texacone.com

TEXACONE CYLINDER HEAD IDENTIFICATION SYSTEM

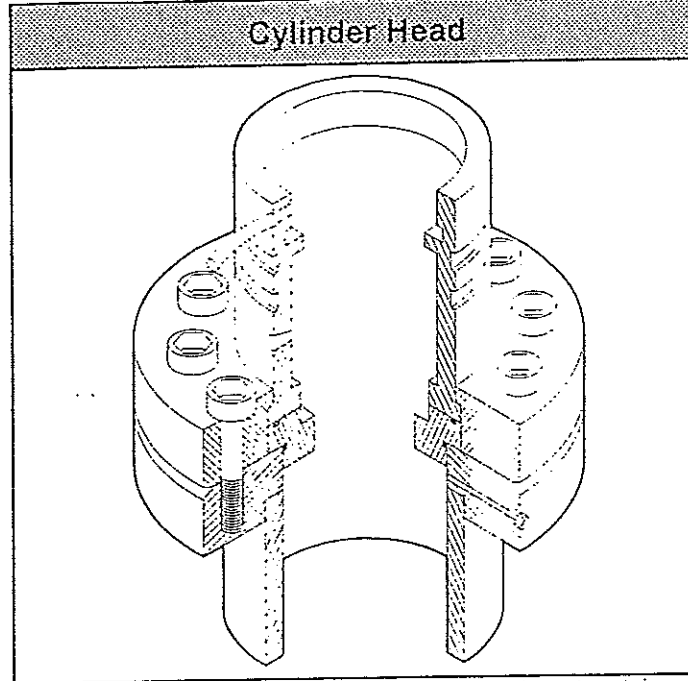
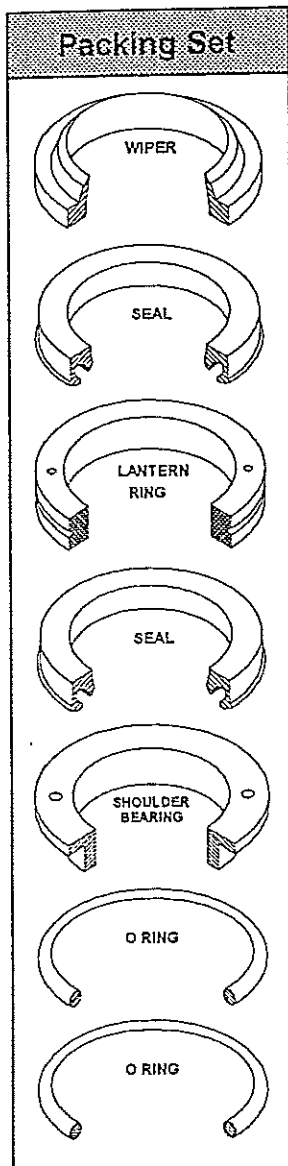

Illustrations are property of Texacone and may not be reproduced without permission.

**EECO
LJ**

Plunger Size	Packing Set Number	Replacement Seal Number*
2-3/4	6EA008-18	8E052 / 6E110SF
3-7/16	6EA008-10	6E040
3-1/2	6EA008-19	6E001
3-7/8	6EA008-11	8E001 / 6E205SF
4	6EA008-12	8E058 / 6E005
4-3/8	6EA008-01	8E007 / 6E206SF
5	6EA008-02	8E051 / 6E020
5-7/16	6EA008-03	8E023 / 6E219 SF
6	6EA008-04	8E036 / 6E028
6-1/2	6EA008-05	8E026 / 6E208 SF
7-1/2	6EA008-06	8E037 / 6E029
8-1/2	6EA008-07	6E030
10-5/8	6EA008-08	6E042
12-5/8	6EA008-09	6E041
TLJ - Telescopic (requires 2 sets plus reverse seal)		
3-1/2 TLJ	6EA008-19	6E171SF REVERSE
-	6EA008-03	-
4-3/8 TLJ	6EA008-01	6E063 REVERSE
-	6EA008-05	-

*Sets are provided as Reduced-Friction Sets.
Specify Reduced-Friction when ordering replacement seals as both seals are needed.

EECO-LJ

© 1995 THE TEXACONE COMPANY, INC.

TEXACONE CYLINDER HEAD IDENTIFICATION SYSTEM

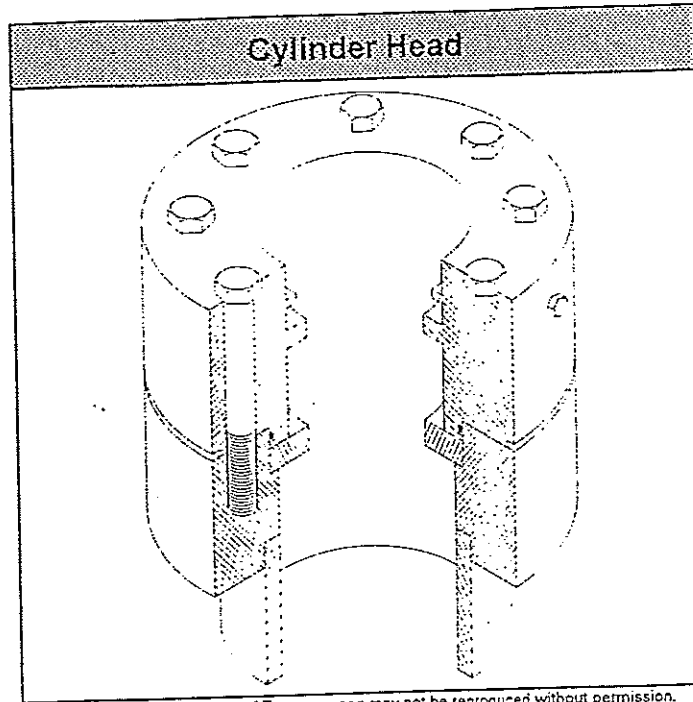
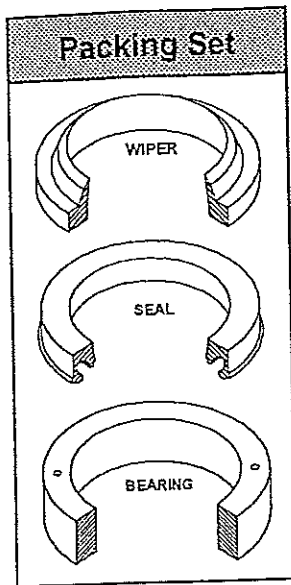

**EECO
NJ & PJ**

Plunger Size	Packing Set Number	Replacement Seal Number
2-3/4	6EA115-01	8E052
3	6EA115-02	8E041
3-7/16	6EA115-03	8E030
3-7/8	6EA115-04	8E001
4	6EA115-05	8E058
4-3/8	6EA115-06	8E007
5	6EA115-07	8E051
5-7/16	6EA115-08	8E023
6	6EA115-09	8E036
6-1/2	6EA115-10	8E026

NJ unit uses retaining rings with bolts - set configuration is the same.

EECO NJ & PJ

© 1998 THE TEXACONE COMPANY, INC.

TEXACONE®

800.235.2727 FAX 972.289.6285
www.texacone.com

TEXACONE CYLINDER HEAD IDENTIFICATION SYSTEM

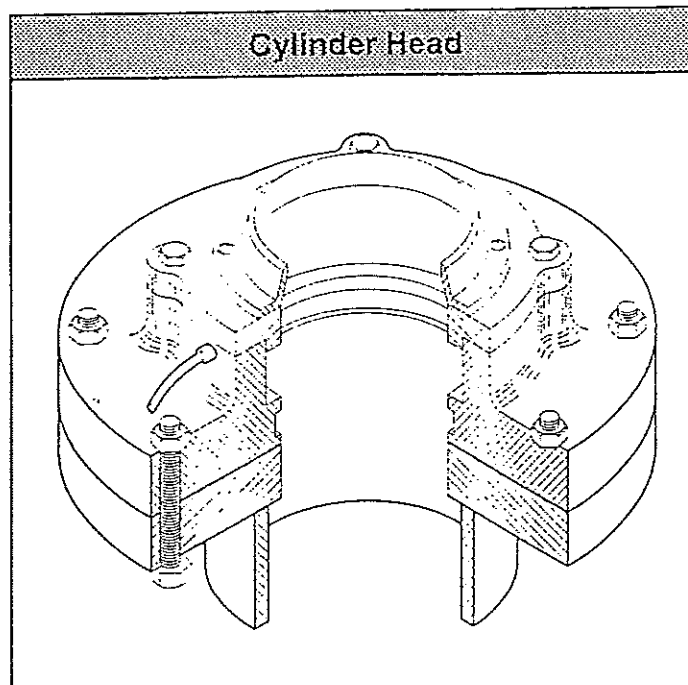
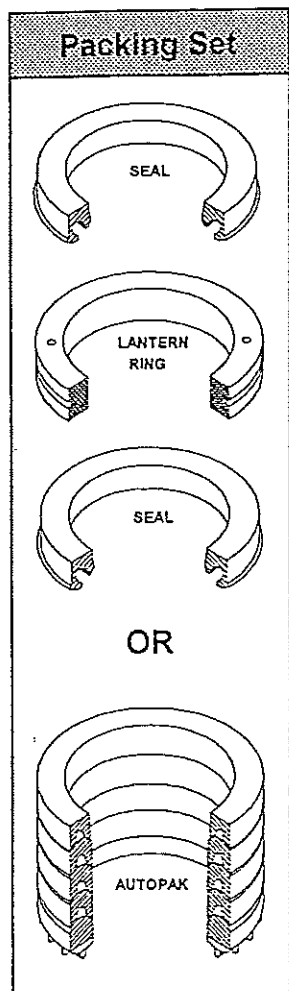

Illustrations are property of Texacone and may not be reproduced without permission.

**ESCO
P3, P5, & P7**

Plunger Size	Packing Set Number	Replacement Seal Number	Autopak Set Number
2-1/2	3EA024-01	3E005	1A092-01
3	3EA024-02	6E227SF	1A092-02
4	3EA024-03	6E005	1A092-03
4-1/2	3EA024-04	6E161SF	1A092-04
5	3EA024-05	6E020	1A092-05
5-1/2	3EA024-06	6E221SF	1A092-06
6	3EA024-07	6E028	1A092-07
6-1/2	3EA024-35	6E208SF	1A092-08
7	3EA024-08	6E035	1A092-09
7-1/2	3EA024-36	6E029	1A092-17
8	3EA024-09	6E037	1A092-10
9	3EA024-10	6E076	1A092-11
10-5/8	3EA024-11	6E042	1A092-12
12-5/8	3EA024-12	6E041	1A092-13
13-7/8	3EA024-32	3E080	1A092-14
15-7/8	3EA024-33	3E081	1A092-15
17-7/8	3EA024-34	3E082	1A092-16

3E079

ESCO-P3, P5, P-7

TEXACONE CYLINDER HEAD IDENTIFICATION SYSTEM

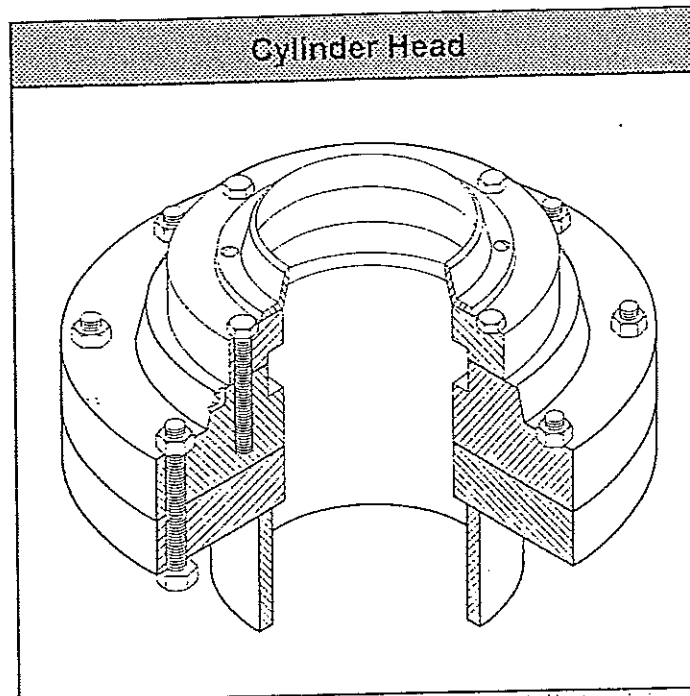
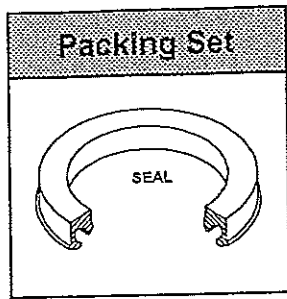

Illustrations are property of Texacone and may not be reproduced without permission.

**ESCO
P-4 - Line Seal**

Plunger Size	Packing Set Number	Replacement Seal Number
4	3EA024-13	6E005
4-1/2	3EA024-14	6E161SF
5	3EA024-15	6E020
5-1/2	3EA024-16	6E221SF
6	3EA024-17	6E028
7	3EA024-18	6E035
8	3EA024-19	6E037
9	3EA024-20	6E070
10-5/8	3EA024-21	6E042

The conventional seal replaces the line seals used between 1966 and 1972. To install the conventional seal simply flip the top flange over to where the previous bottom is now on the top and then bolt down.

3E079

ESCO - P4

© 1998 THE TEXACONE COMPANY, INC.

TEXACONE CYLINDER HEAD IDENTIFICATION SYSTEM

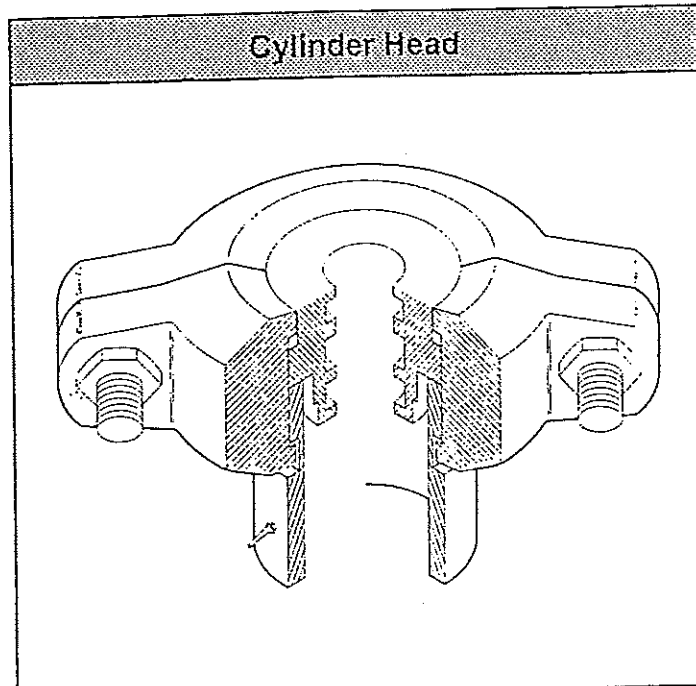
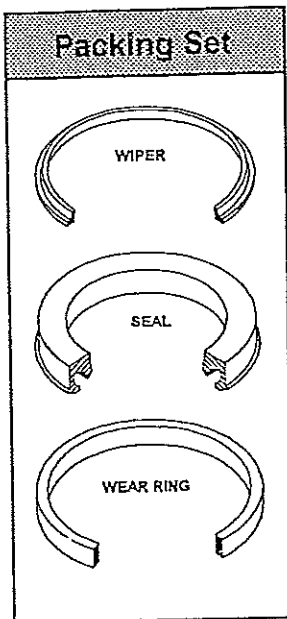

**ESCO
P-6 - Victaulic**

Plunger Size	Packing Set Number	Replacement Seal Number
4	3EA024-22	6E165SF
4-1/2	3EA024-23	6E168SF
5	3EA024-24	6E169SF
5-1/2	3EA024-25	6E171SF
6	3EA024-26	6E172SF
6-1/2	3EA024-30	6E173SF
7	3EA024-27	6E174SF

For plungers larger than 7" the Victaulic head requires the same configuration as P-3 head.

6E165SF

ESCO - P-6 - VICTAULIC

© 1993 THE TEXACONE COMPANY, INC.

TEXACONE®

800.235.2727 FAX 972.289.6285
www.texacone.com

TEXACONE CYLINDER HEAD IDENTIFICATION SYSTEM

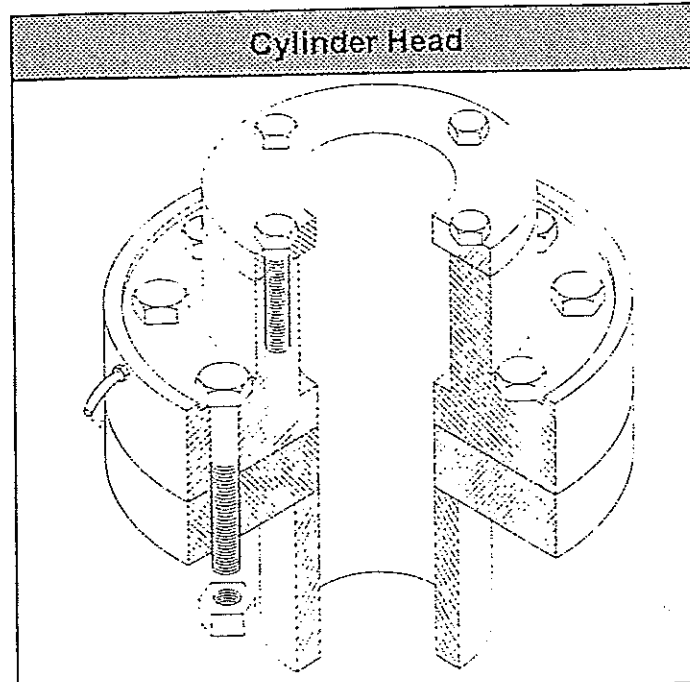
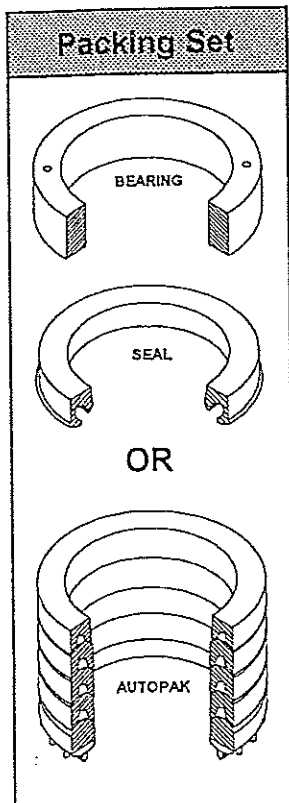

Illustrations are property of Texacone and may not be reproduced without permission.

General (FL)
(Steel and Aluminum Heads)

Plunger Size	Packing Set Number	Replacement Seal Number	Autopak Set Number
3-1/2	6EA014-01	6E001	1A105-01
4-7/16	6EA014-02	6E032	1A105-02
4-1/2	6EA014-10	6E161SF	1A105-03
5-7/16	6EA014-03	6E219SF	1A105-04
6-7/16	6EA014-04	6E070	1A105-05
6-1/2	6EA014-05	6E208SF	1A105-06
7-1/2	6EA014-06	6E029	1A105-07
8-1/2	6EA014-07	6E030	1A105-08
9-1/2	6EA014-08	6E039	1A105-09
10-1/2	6EA014-09	1E007	1A105-10

When using Autopak, reuse existing solid bearing.

6E141

GENERAL

© 1993 THE TEXACONE COMPANY, INC.

TEXACONE®

800.235.2727 FAX 972.289.6285
www.texacone.com

TEXACONE CYLINDER HEAD IDENTIFICATION SYSTEM

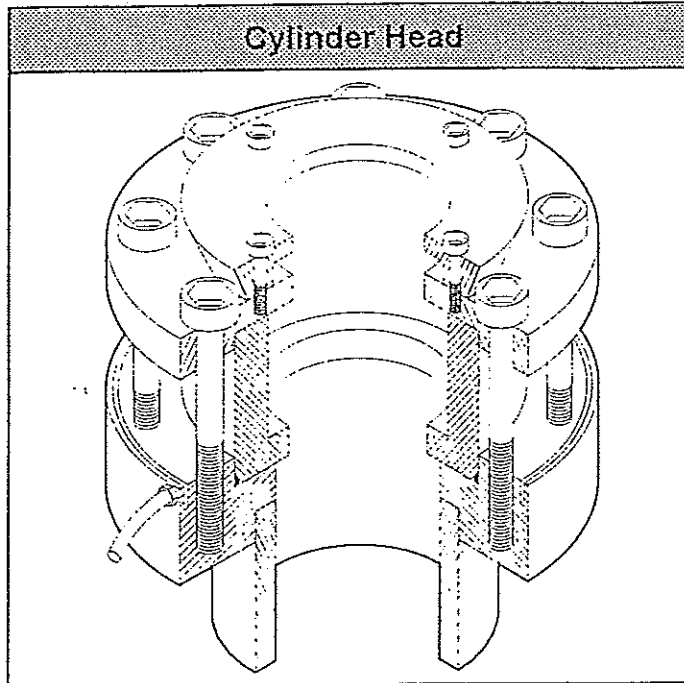
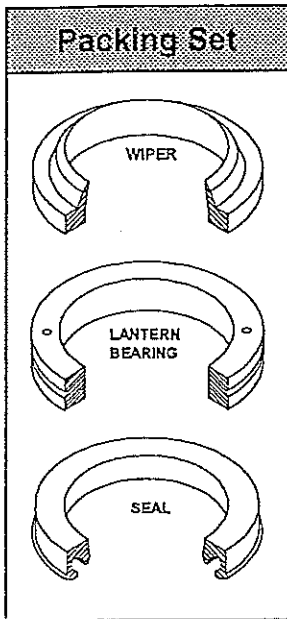

Illustrations are property of Texacone and may not be reproduced without permission.

Hollister - Whitney

Plunger Size	Packing Set Number	Replacement Seal Number
4-3/8	6EA017-01	6E206SF
4-1/2	6EA017-02	6E161SF
5-3/8	6EA017-03	6E047
5-7/16	6EA017-04	6E219SF
6-1/2	6EA017-05	6E208SF
7-1/2	6EA017-06	6E029
8-1/2	6EA017-07	6E030
10-5/8	6EA017-08	6E042

HOLLISTER-WHITNEY

© 1998 THE TEXACONE COMPANY, INC.

TEXACONE CYLINDER HEAD IDENTIFICATION SYSTEM

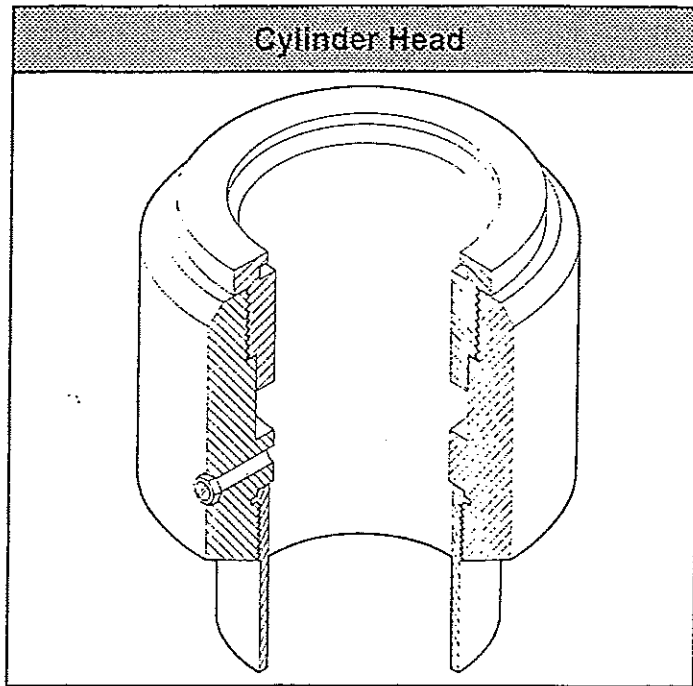
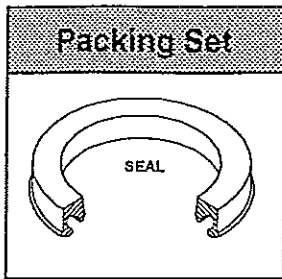

Illustrations are property of Texacone and may not be reproduced without permission.

ITI

Plunger Size	Replacemnt Seal Number
1-1/2	8E082
2	8E083
2-1/2	8E079
2-3/4	8E052
2-7/8	8E057
3	8E041
3-1/2	8E081
3-3/4	8E046
4	8E067
4-1/4	8E101
4-7/16	8E076
4-1/2	8E071
4-7/8	8E095
5	8E107
5-3/8	8E091
5-1/2	8E068
6	8E105
6-1/2	8E008

NOTE: Other sizes available, please inquire.

© 1998 THE TEXACONE COMPANY, INC.

TEXACONE®

800.235.2727 FAX 972.289.6285
www.texacone.com

TEXACONE CYLINDER HEAD IDENTIFICATION SYSTEM

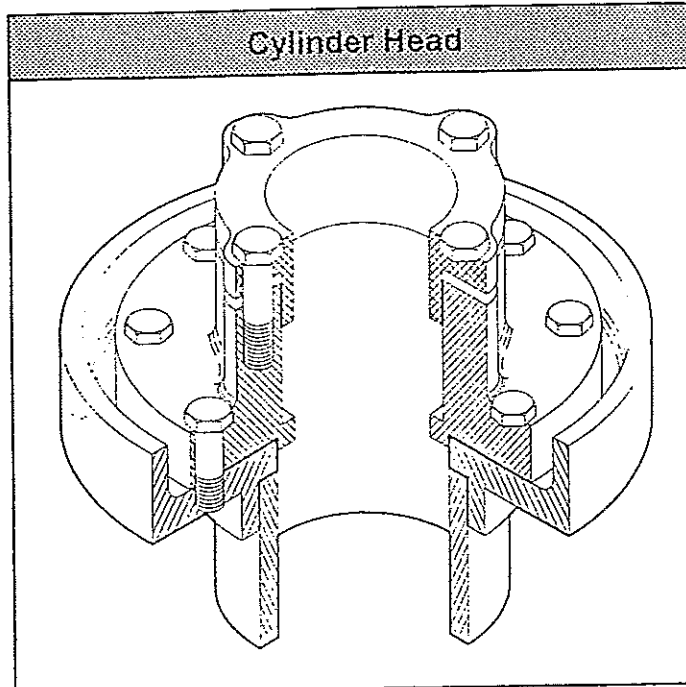
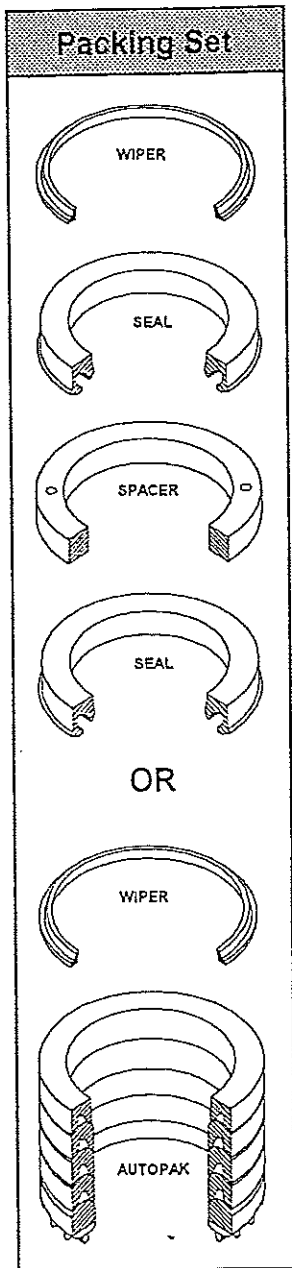

Illustrations are property of Texacone and may not be reproduced without permission.

Montgomery Bronze			
Plunger Size	Packing Set Number	Replacement Seal Number	Autopak Set Number*
3-15/16	3EA026-11	6E019	1A074-01
4.460	3EA026-12	6E032	1A074-02
5.520	3EA026-13	6E221SF	1A074-03
5.720	3EA026-14	6E003	1A074-04
6.590	3EA026-15	6E089	1A074-05
7.470	3EA026-16	6E029	1A074-06
8.570	3EA026-17	6E064	1A074-07
9.470	3EA026-18	6E039	1A074-08
10.7	3EA026-19**	6E051	1A074-09
12.7	3EA026-20**	6E052	1A074-10

NOTE: Always reuse existing filler ring.
 *Autopak is the recommended replacement packing.
 **Two additional spacers are included with these sets.

3E003
3E089

MONTGOMERY - BRONZE

© 1998 THE TEXACONE COMPANY, INC.

TEXACONE®

800.235.2727 FAX 972.289.6285
www.texacone.com

TEXACONE CYLINDER HEAD IDENTIFICATION SYSTEM

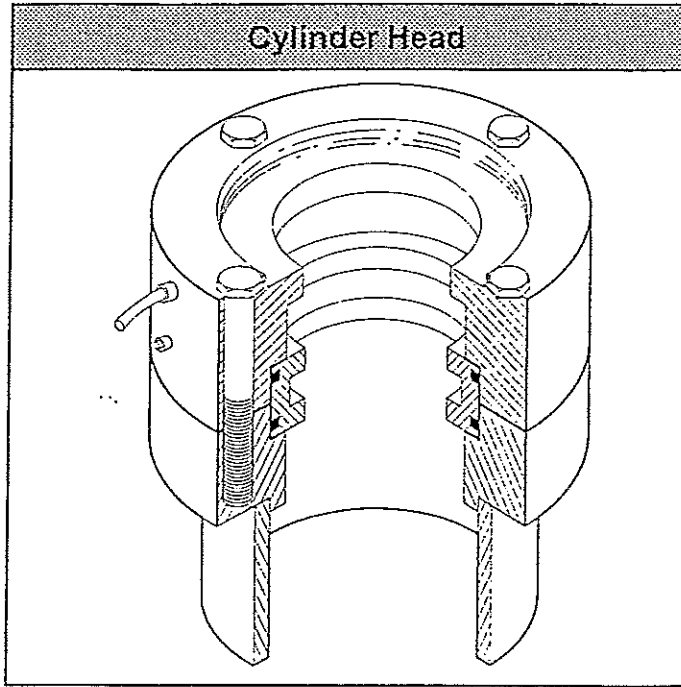
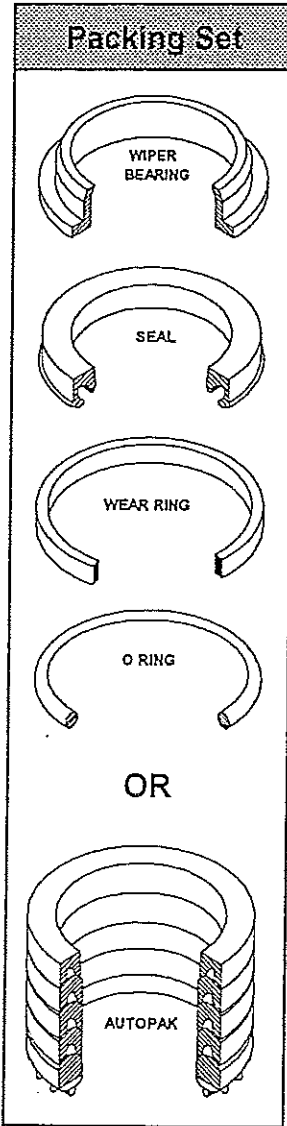

Illustrations are property of Texacone and may not be reproduced without permission.

Montgomery Holeless

Plunger Size	Packing Set Number	Replacement Seal Number	Autopak Set Number
2.84	6EA018-03	8E009	-
3	6EA018-01	8E002	1A079
3-1/2	6EA018-02	8E004	1A080

MONTGOMERY - HOLELESS

© 1999 THE TEXACONE COMPANY, INC.

TEXACONE CYLINDER HEAD IDENTIFICATION SYSTEM

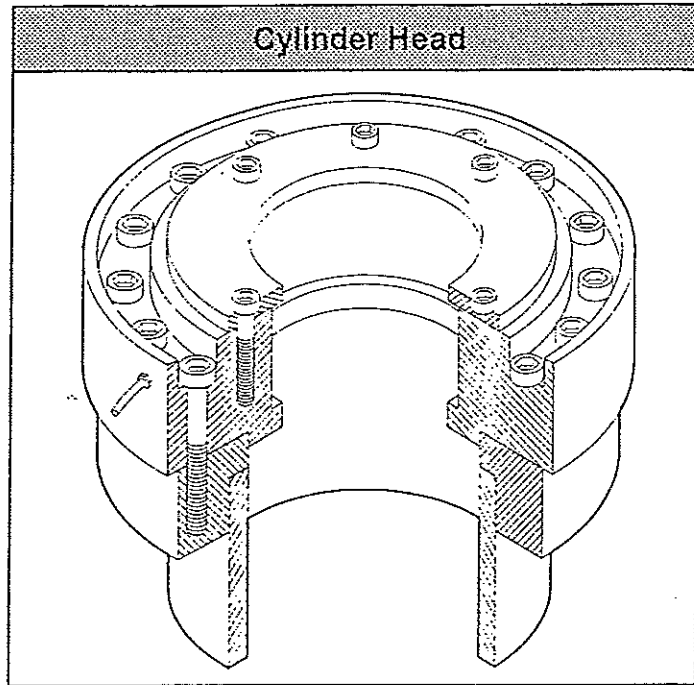
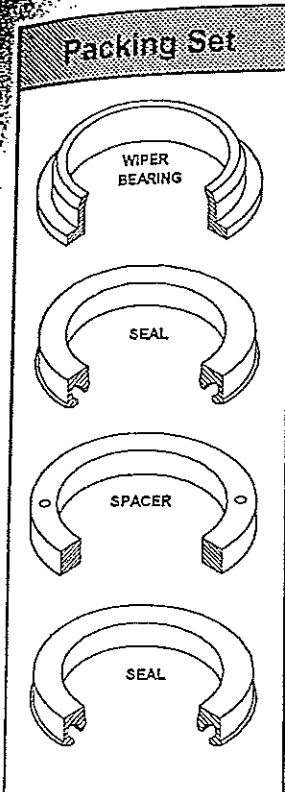

Illustrations are property of Texacone and may not be reproduced without permission.

Montgomery New 1993

Plunger Size	Packing Set Number	Replacement Seal Number
9.47	3EA026-24	6E039
10.7	3EA026-21	6E051
12.7	3EA026-22	6E052

© 1998 THE TEXACONE COMPANY, INC.

TEXACONE®

800.235.2727 FAX 972.289.6285
www.texacone.com

MONTGOMERY - NEW 1993

TEXACONE CYLINDER HEAD IDENTIFICATION SYSTEM

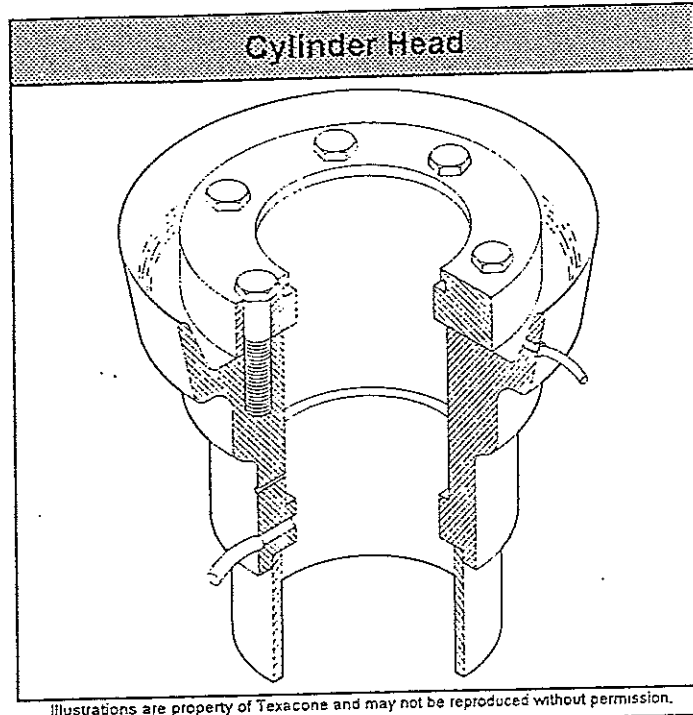
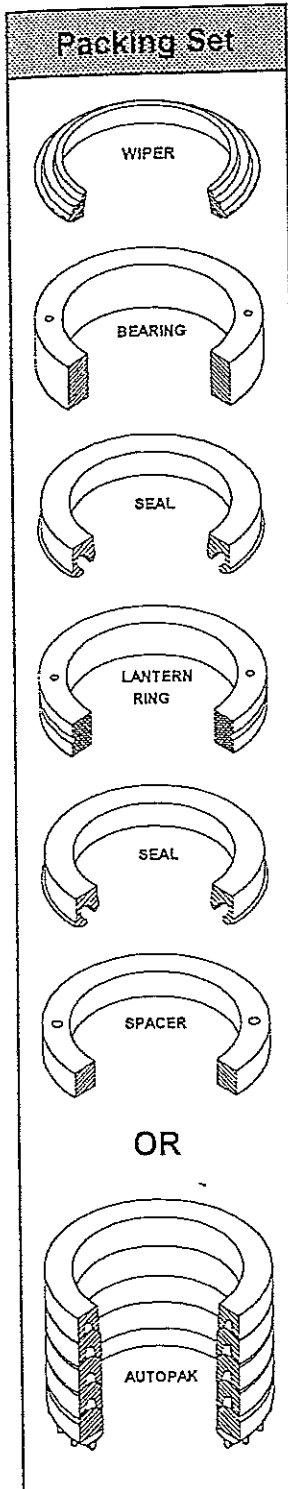

**Otis
Cast Head**

Plunger Size*	Packing Set Number	Replacement Seal Number	Autopak Set Number
4 (3-7/8)	6EA001-01	6E205SF	1A085-01
4-1/2 (4-3/8)	6EA001-02	6E206SF	1A085-02
5-1/2 (5-7/16)	6EA001-03	6E219SF	1A085-03
6-1/2 (6-1/2)	6EA001-04	6E208SF	1A085-04
7-1/2 (7-1/2)	6EA001-05	6E029	1A085-05
8-1/2 (8-1/2)	6EA001-06	6E053	1A085-06
9-1/2 (9-1/2)	6EA001-07	6E054	1A085-07
10-1/2 (10-5/8)	6EA001-08	6E051	1A085-08
12-1/2 (12-5/8)	6EA001-09	6E052	1A085-09
14 (13-3/4)	6EA001-10	6E063	1A085-10
16 (15-3/4)	6EA001-11	1E038	1A085-11

This unit was manufactured prior to 1974.
*Dimension in () is actual plunger size.

OTIS - CAST HEAD

TEXACONE CYLINDER HEAD IDENTIFICATION SYSTEM

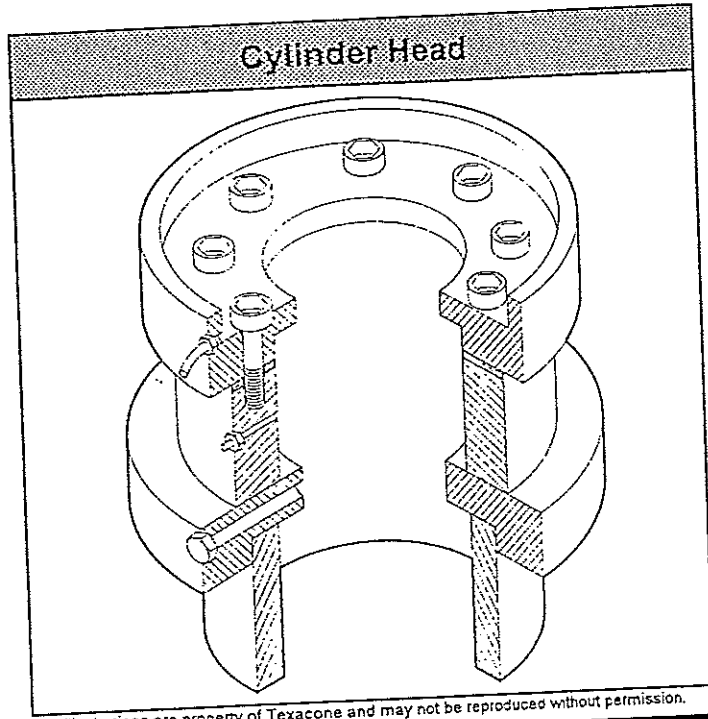
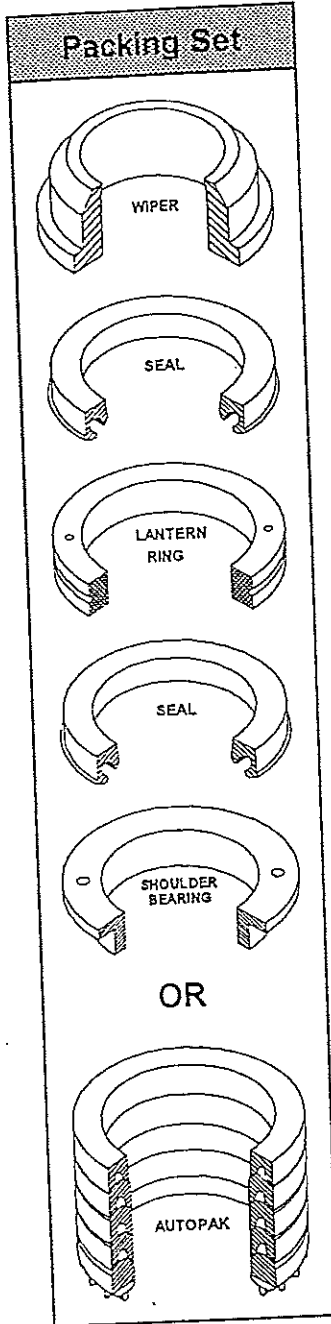

Illustrations are property of Texacone and may not be reproduced without permission.

Otis AP-Welded			
Plunger Size*	Packing Set Number	Replacement Seal Number**	Autopak Number
4 (3-7/8)	6EA114-05	8E001 / 6E205SF	1A085-01
4-1/2 (4-3/8)	6EA114-06	8E007 / 6E206SF	1A085-02
5 (4-7/8)	6EA114-09	6E207SFSS	1A085-12
5-1/2 (5-7/16)	6EA114-07	8E023 / 6E219SF	1A085-03
6-1/2 (6-1/2)	6EA114-08	8E026 / 6E208SF	1A085-04

This unit was manufactured from 1974 to 1993.
 *Dimension in () is actual plunger size.
 **Sets are provided as Reduced-Friction Sets.
 Specify reduced friction when ordering replacement seals as both seals listed are required.

OTIS - AP WELDED

TEXACONE CYLINDER HEAD IDENTIFICATION SYSTEM

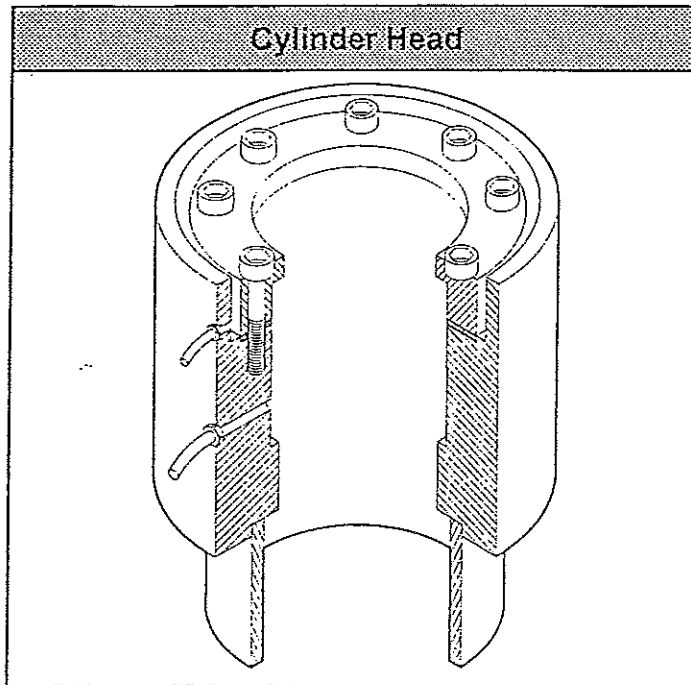
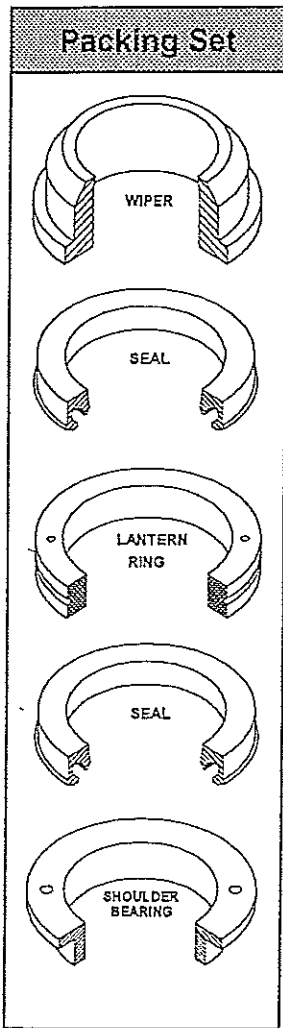

Illustrations are property of Texacone and may not be reproduced without permission.

**Otis
AP Welded - New 1993**

Plunger Size	Packing Set Number	Replacement Seal Number*
3.93	6EA114-01	8E017 / 6E246SF
4.43	6EA114-02	8E006 / 6E247SF
5.50	6EA114-03	8E020 / 6E248SF
6.56	6EA114-04	8E018 / 6E249SF

This unit was manufactured after 1993.

*Sets are provided as Reduced-Friction Sets.
Specify reduced friction when ordering replacement seals as both seals listed are required.

OTIS - AP - NEW 1993

© 1993 THE TEXACONE COMPANY, INC.

TEXACONE CYLINDER HEAD IDENTIFICATION SYSTEM

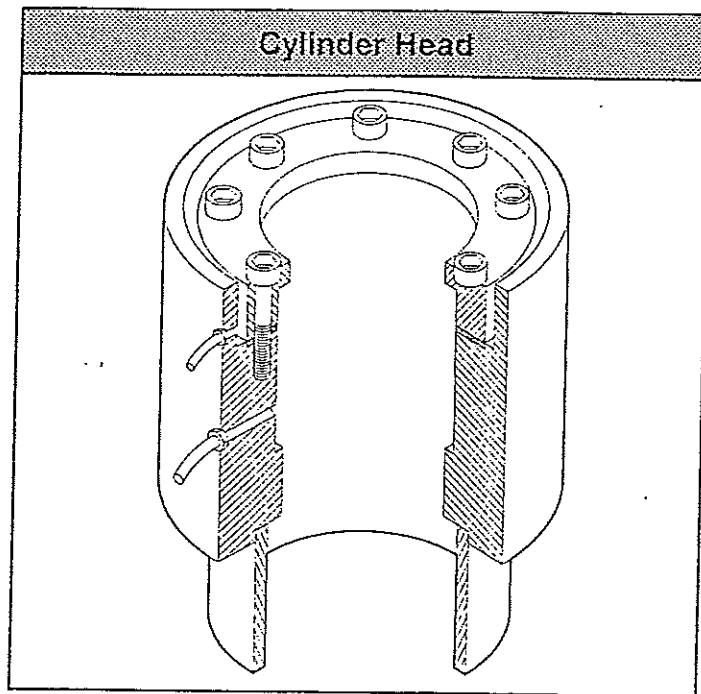
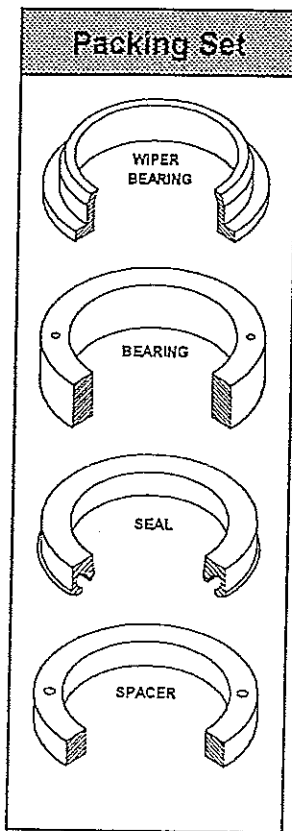

Illustrations are property of Texacone and may not be reproduced without permission.

**Otis
Holeless**

Plunger Size	Packing Set Number	Replacement Seal Number
2-3/4	6EA004	8E028
2.84	6EA103*	8E009

*Alternative set is available for severe service conditions.
~~6EA100.~~

OTIS - HOLELESS

TEXACONE CYLINDER HEAD IDENTIFICATION SYSTEM

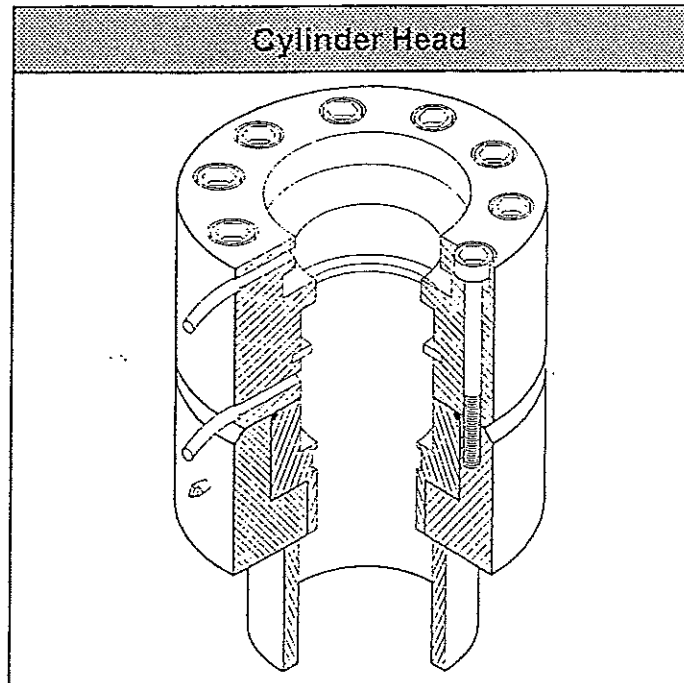
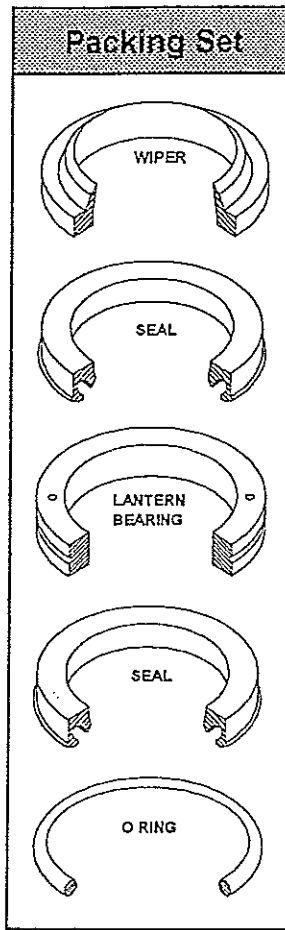

Illustrations are property of Texacone and may not be reproduced without permission.

Otis / Cemco

Plunger Size	Packing Set Number	Replacement Seal Number*
3-7/8	6EA110-05	8E001 / 6E205SF
3.93	6EA110-01	8E017 / 6E246SF
4-3/8	6EA110-06	8E007 / 6E206SF
4.43	6EA110-02	8E006 / 6E247SF
5-7/16	6EA110-07	8E023 / 6E219SF
5.50	6EA110-03	8E020 / 6E248SF
6.50	6EA110-10**	8E026 / 6E208SF
6.56	6EA110-09**	8E018 / 6E249SF

*Sets are provided as Reduced-Friction Sets. Specify Reduced-Friction when ordering replacement seals as both seals are needed.

**These cylinder heads look like the Cemco - Flange head.

OTIS / CEMCO

TEXACONE CYLINDER HEAD IDENTIFICATION SYSTEM

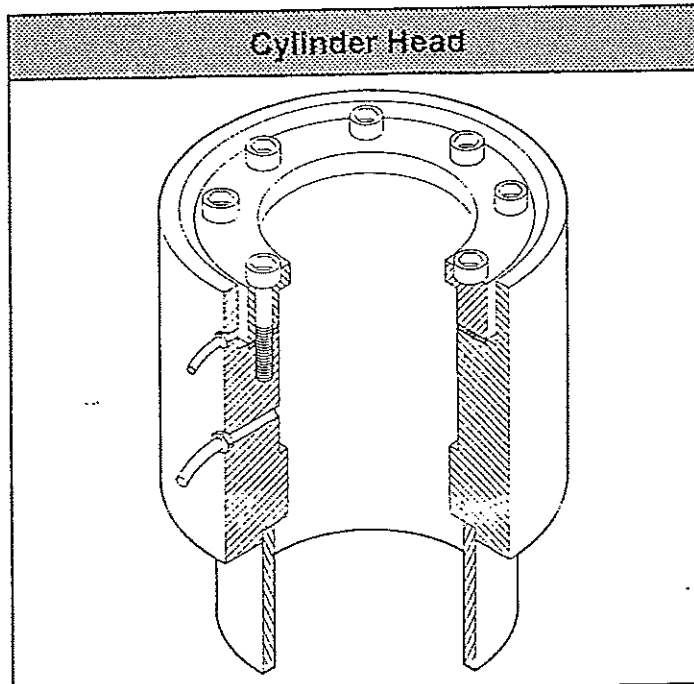
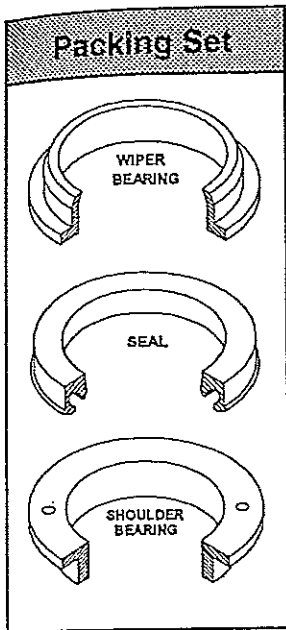

Illustrations are property of Texacone and may not be reproduced without permission.

**Otis
Holeless (Roped)**

Plunger Size	Packing Set Number	Replacement Seal Number
3.938	6EA104-01	8E017
4.438	6EA104-02	8E006
5.500	6EA104-03	8E020

© 1998 THE TEXACONE COMPANY, INC.

TEXACONE®

800.235.2727 FAX 972.289.6285
www.texacone.com

OTIS HOLELESS (ROPED)

TEXACONE CYLINDER HEAD IDENTIFICATION SYSTEM

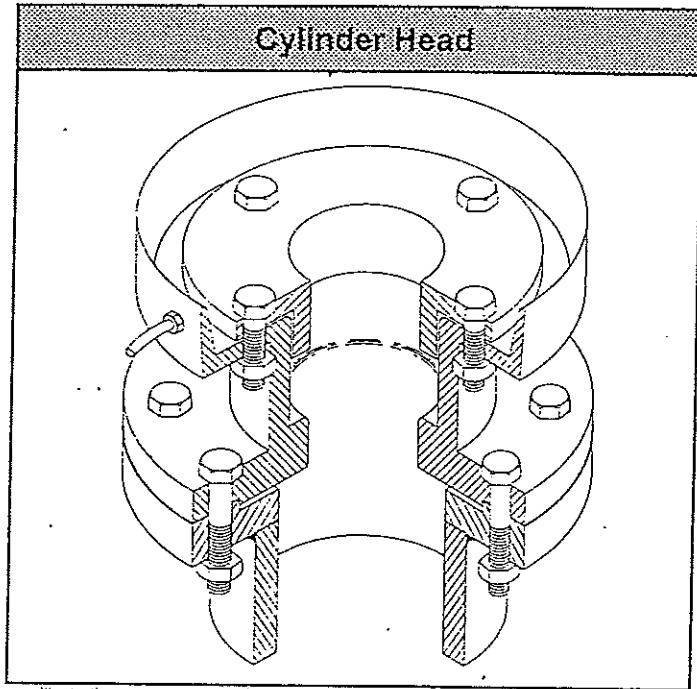
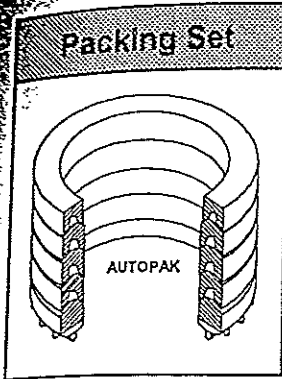

Illustrations are property of Texacone and may not be reproduced without permission.

R & O Cast Head

Plunger Size	Autopak Set Number
4-3/8	1A090-01
4-1/2	1A090-02
5-7/16	1A090-03
5-1/2	1A090-04
6-1/2	1A090-05
8-1/2	1A090-06
10-1/2	1A090-07

NOTE: Manufactured prior to 1971.

© 1993 THE TEXACONE COMPANY, INC.

TEXACONE®

800.235.2727 FAX 972.289.6285
www.texacone.com

R & O - CAST HEAD

TEXACONE CYLINDER HEAD IDENTIFICATION SYSTEM

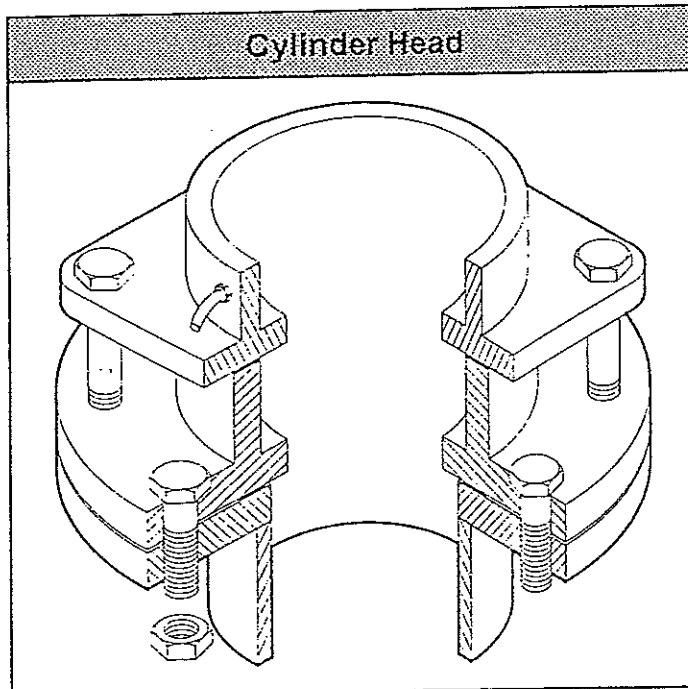
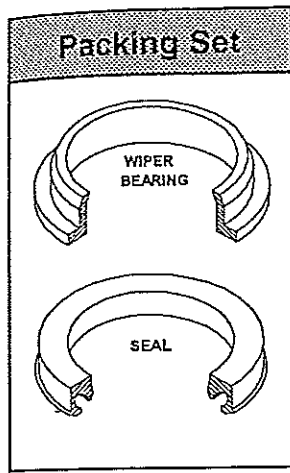

Illustrations are property of Texacone and may not be reproduced without permission.

**R & O
Model 71 & 76**

Plunger Size	Packing Set Number	Replacement Seal Number
4-3/8	6EA013-01	8E007
5-7/16	6EA013-02	8E023
6-1/2	6EA013-03	8E026

Model 71: manufactured from 1971 to 1975.
 Model 76: manufactured from 1975 to 1978.

R & O - MODEL 71 & 76

© 1992 THE TEXACONE COMPANY, INC.

TEXACONE CYLINDER HEAD IDENTIFICATION SYSTEM

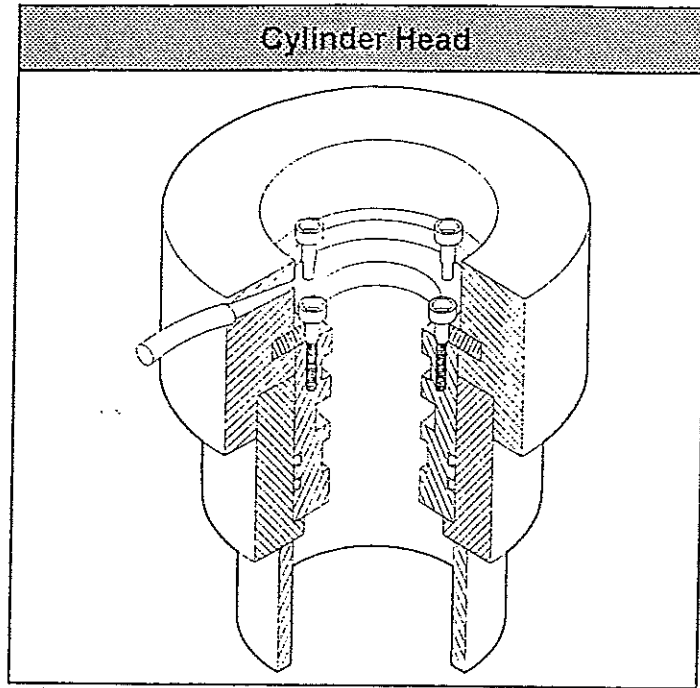
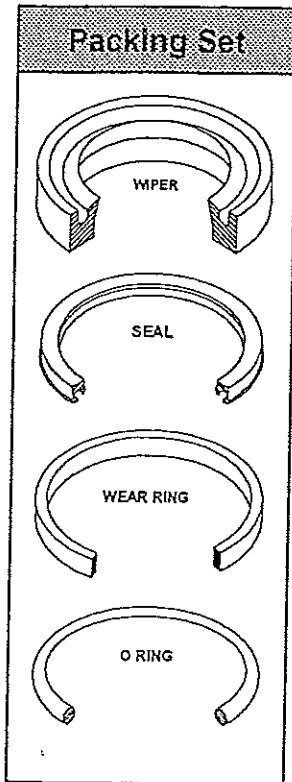

Illustrations are property of Texacone and may not be reproduced without permission.

SCHINDLER - MPH

Schindler MPH - F Series		
Plunger Size	Packing Set Number	Replacement Seal Number
3-1/2	6EA113-01	7E010
3-3/4	6EA113-02	7E007
4	6EA113-03	7E011
4-1/2	6EA113-04	7E008
5	6EA113-05	7E009
5-1/2	6EA113-06	7E012
6	6EA113-07	7E013
6-1/2	6EA113-08	7E014
7	6EA113-09	7E015
8	6EA113-10	7E016

© 1998 THE TEXACONE COMPANY, INC.

TEXACONE®

800.235.2727 FAX 972.289.6285
www.texacone.com

TEXACONE CYLINDER HEAD IDENTIFICATION SYSTEM

Packing Set

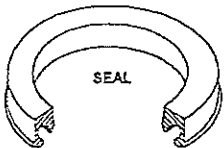
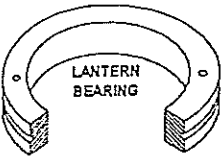
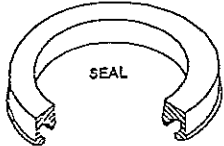
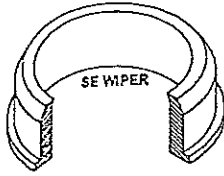

OR

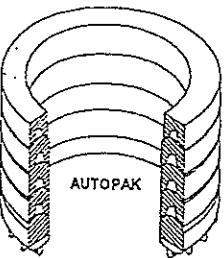

Cylinder Head

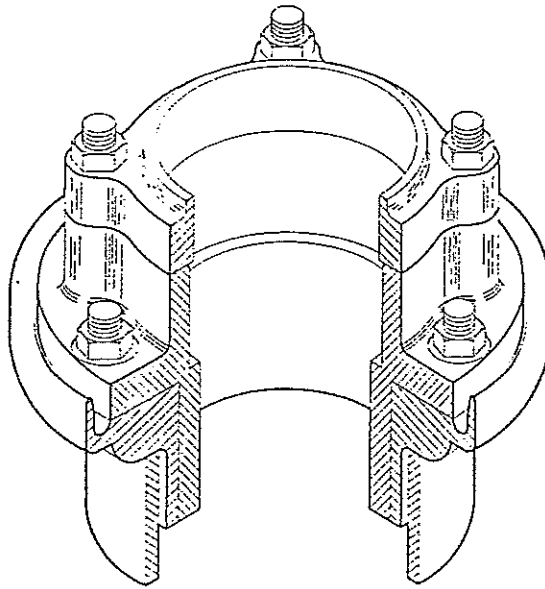

Illustrations are property of Texacone and may not be reproduced without permission.

Southeastern

Plunger Size	Packing Set Number	Replacement Seal Number	Autopak Set Number
4-3/8	6EA007-01	6E206	1A086-01
5	6EA007-02	6E020	1A086-02
5-1/2	6EA007-03	6E221	1A086-03
6-1/2	6EA007-04	6E208	1A086-04
6-9/16	6EA007-05	6E031	1A086-05
7-1/2	6EA007-06	6E029	1A086-06
8-1/2	6EA007-07	6E030	1A086-07
9-1/2	6EA007-08	6E039	1A086-08
10-5/8	6EA007-09	6E042	1A086-09
12-5/8	6EA007-10	6E041	1A086-10

Other sizes available.

SOUTHEASTERN

TEXACONE CYLINDER HEAD IDENTIFICATION SYSTEM

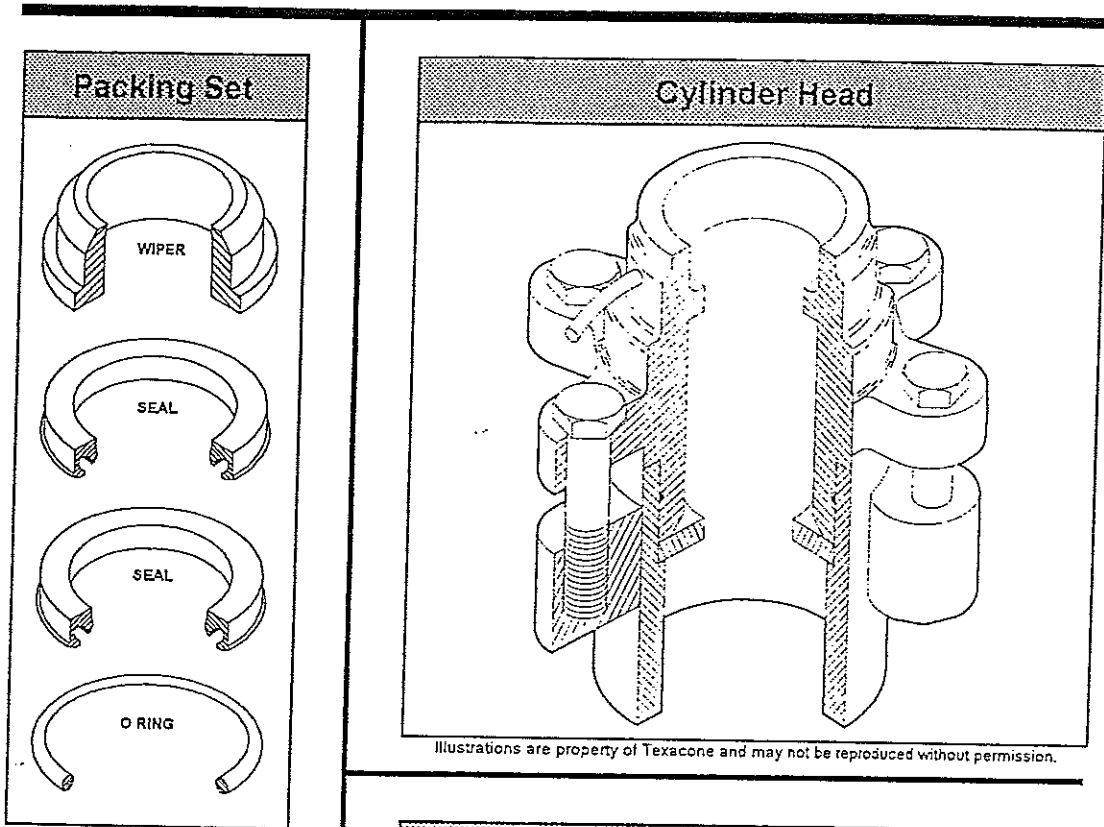

Illustrations are property of Texacone and may not be reproduced without permission.

United		
Plunger Size	Packing Set Number	Replacement Seal Number
3-15/16	6EA033-01	6E019
4-7/16	6EA033-02	6E032
5	6EA033-03	6E020
5-1/2	6EA033-04	6E221SF
5-9/16	6EA033-13*	6E050
6	6EA033-05	6E028
6-1/2	6EA033-14	6E024
6-9/16	6EA033-06	6E031
6-5/8	6EA033-15*	6E186SF
7-1/2	6EA033-16	6E029
7-9/16	6EA033-07	6E059
7-5/8	6EA033-17*	6E240 SF
8-1/2	6EA033-18	6E030
8-9/16	6EA033-08	6E064
8-5/8	6EA033-19*	6E222 SF

Old and New units require same packing.
 No lantern ring supplied.
 *Wiper not available in these sizes.

© 1998 THE TEXACONE COMPANY, INC.

TEXACONE CYLINDER HEAD IDENTIFICATION SYSTEM

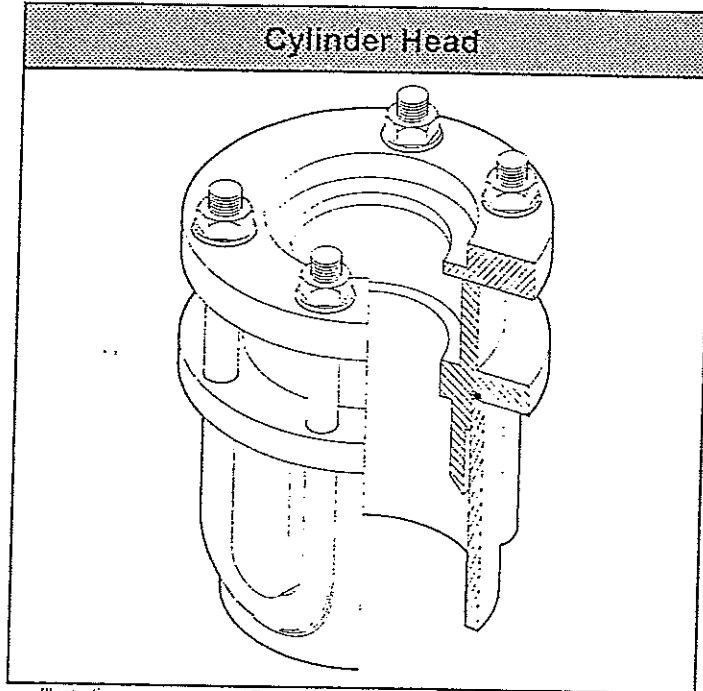
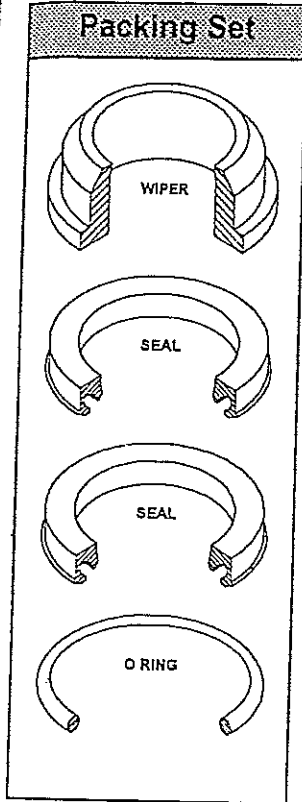

Illustrations are property of Texacone and may not be reproduced without permission.

UNITED - NEW

United New		
Plunger Size	Packing Set Number	Replacement Seal Number
3-15/16	6EA033-01	6E019
4-7/16	6EA033-02	6E032
5	6EA033-03	6E020
5-1/2	6EA033-04	6E221SF
5-9/16	6EA033-13*	6E050
6	6EA033-05	6E028
6-1/2	6EA033-14	6E024
6-9/16	6EA033-06	6E031
6-5/8	6EA033-15*	6E186SF
7-1/2	6EA033-16	6E029
7-9/16	6EA033-07	6E059
7-5/8	6EA033-17*	6E240 SF
8-1/2	6EA033-18	6E030
8-9/16	6EA033-08	6E064
8-5/8	6EA033-19*	6E222 SF

Old and New units require same packing.
No lantern ring supplied.
*Wiper not available in these sizes.

© 1998 THE TEXACONE COMPANY, INC.

TEXACONE®

800.235.2727 FAX 972.289.6285
www.texacone.com

TEXACONE CYLINDER HEAD IDENTIFICATION SYSTEM

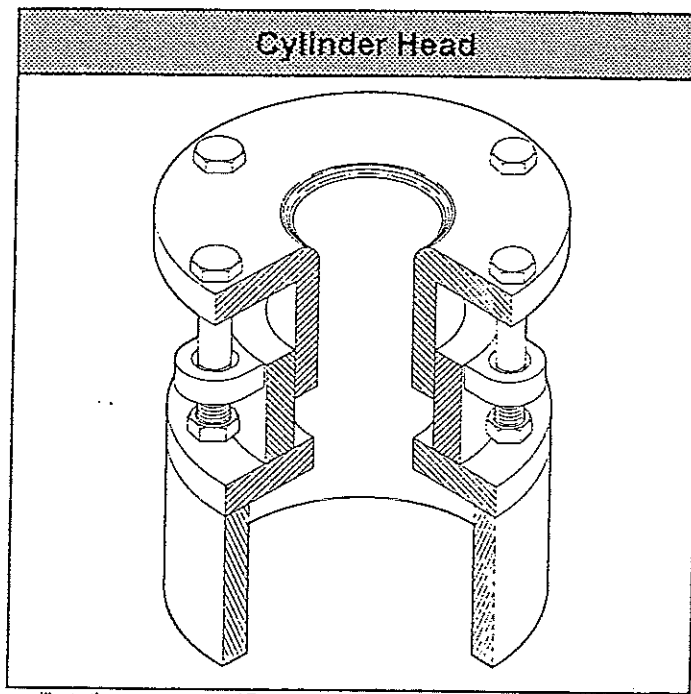
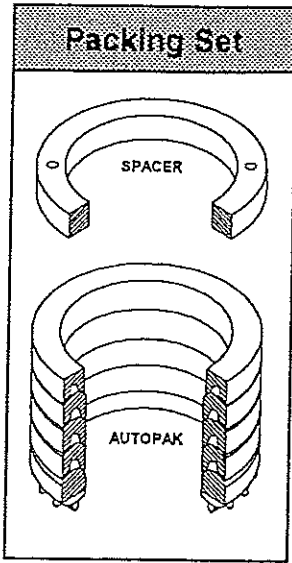

Illustrations are property of Texacone and may not be reproduced without permission.

U.S. - ALUMINUM

U.S. Aluminum	
Plunger Size	Autopak Set Number
3-7/8	1A108-06
4	1A108-05
4-1/2	1A108-01
5	1A108-02
5-1/2	1A108-07
6	1A108-03
7	1A108-04

For U.S. units manufactured prior to 1983.

© 1998 THE TEXACONE COMPANY, INC.

TEXACONE®

800.235.2727 FAX 972.289.6285
www.texacone.com

TEXACONE CYLINDER HEAD IDENTIFICATION SYSTEM

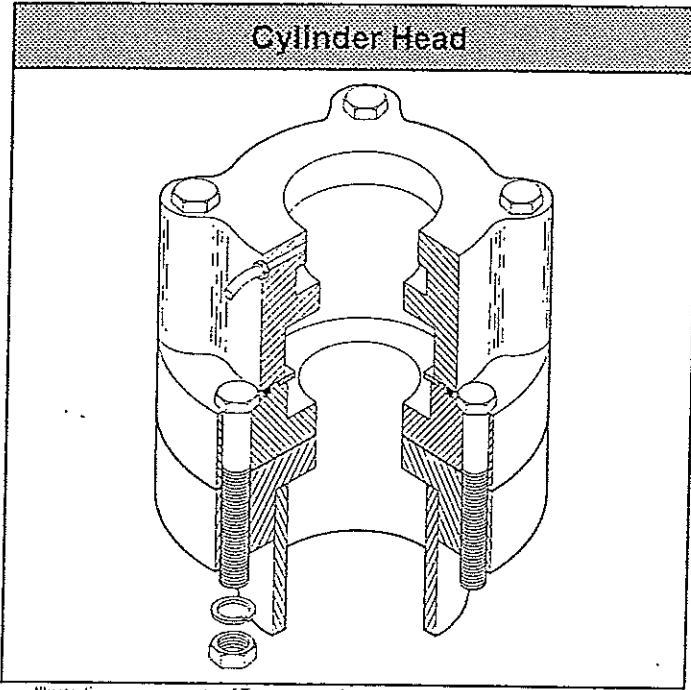
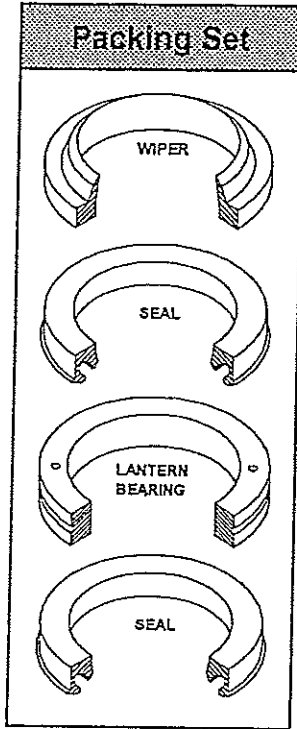

Illustrations are property of Texacone and may not be reproduced without permission.

U.S. MT		
Plunger Size	Packing Set Number	Replacement Seal Number
4	6EA012-01	6E165SF
4-1/2	6EA012-02	6E168SF
5	6EA012-03	6E169SF
5-1/2	6EA012-04	6E171SF
6	6EA012-05	6E172SF
6-1/2	6EA012-06	6E173SF
7	6EA012-07	6E174SF
8-1/2	6EA012-08*	6E177SF

*Wiper not available.
For U.S. units manufactured from 1983 to 1986.

© 1999 THE TEXACONE COMPANY, INC.

TEXACONE®

800.235.2727 FAX 972.289.6285
www.texacone.com

TEXACONE CYLINDER HEAD IDENTIFICATION SYSTEM

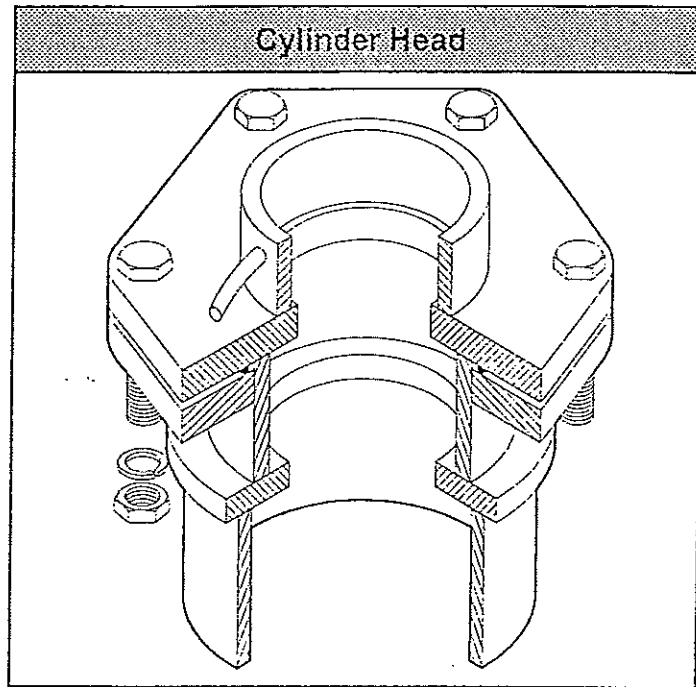
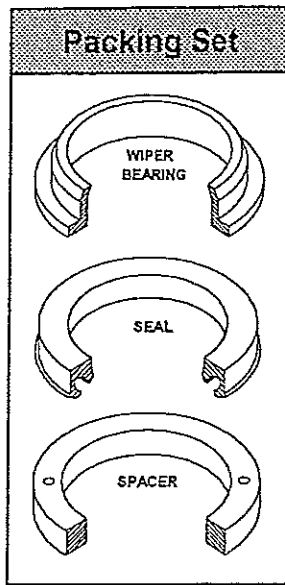

Illustrations are property of Texacone and may not be reproduced without permission.

U.S. - ECONOHEAD

**U.S.
Econohead**

Plunger Size	Packing Set Number	Replacement Seal Number
Type I - manufactured from 1986 to 1990		
2-7/8	6EA069	8E010
3-3/4	6EA083-01	6E114SF
4	6EA083-02	6E128SF
4-1/2	6EA083-03	6E129SF
5	6EA083-04	6E130SF
5-1/2	6EA083-05	6E131SF
6	6EA083-06*	6E028
6-1/2	6EA083-07	6E133SF
6-9/16	6EA083-09	6E116SF
6-5/8	6EA083-08	6E145SF
Type II** - manufactured from 1990 to 1993		
2-7/8	6EA112-01	8E010
3-3/4	6EA112-02	6E114SF
4	6EA112-03	6E128SF
4-1/2	6EA112-04	6E129SF
5-1/2	6EA112-05	6E131SF
6-5/8	6EA112-06	6E145SF

*Seal only available.

**Two or more spacers included in the complete sets for the U.S. Type II units.

© 1998 THE TEXACONE COMPANY, INC.

TEXACONE®

800.235.2727 FAX 972.289.6285
www.texacone.com