

FOREWORD

ELEVATOR WORLD, the National Elevator Industry, Inc. (NEII) and the members of the NEII Safety Committee assume no responsibility for either safety conditions or compliance with legal requirements at any particular jobsite. The safety practices and procedures spelled out within this *Elevator Industry Field Employees' Safety Handbook* are based upon experiences of field personnel and research conducted by many safety specialists. These practices and procedures are not only common-sense precautions to eliminate hazards, prevent incidents and avoid injuries; they are also the recommended methods by which to carry out and complete a job safely. This handbook should be carried and consulted in order for "safety" to become a "way of life" on every construction or maintenance job. Because elevator and escalator components vary from company to company, and because unique or unusual jobsite conditions may exist, it is not possible for a handbook on general safety methods and practices to deal with every possible hazard which may be present at every jobsite. For that reason, each user of this handbook must carefully observe the safety conditions at each jobsite to make certain there are no conditions which would require safety precautions beyond those described in this handbook. This handbook is believed to be accurate at the time of publication; however, changes in law, regulations and/or interpretations may invalidate certain portions. It is the responsibility of the employer to be familiar with all appropriate State and Federal regulations. Written and edited by the NEII Safety Committee in cooperation with ELEVATOR WORLD. Published by and available from Elevator World, Inc., P.O. Box 6507, Mobile, Alabama 36660. This handbook is also available online at <http://safety.elevator-world.com>. Revisions are kept current online. © Copyright 2005. All rights reserved by Elevator World, Inc.

PREFACE

This Handbook is designed to provide a resource for safety information that the elevator industry field employees shall use to help prevent injuries and illnesses resulting from unsafe acts and/or conditions.

The intent of this Handbook is to promote jobsite safety through adherence to OSHA safety regulations affecting the elevator industry and other trades working with us. Directions to field personnel affecting the general public are incidental to the purpose of the Handbook and therefore should not be construed to be complete as to the proper way to safeguard the public. This Handbook is also not intended to be used as a guide, standard or code on the installation, repair or servicing of elevators.

This Handbook is intended to augment a company safety program. It is not intended to be used as the total company safety program (policy).

All elevator industry employees shall familiarize themselves with the contents of this Handbook. The safety procedures apply to all persons working on elevator, escalator, moving walk, material lift and dumbwaiter equipment directly employed by elevator companies.

NEII SAFETY COMMITTEE

December 2006



Fred Wilt, Chair NEII Safety Committee
Field Safety Manager
Schindler Elevator Corp.

Edward A. Donoghue, CPCA,
Secretary NEII Safety Committee
Edward A Donoghue Associates Inc.
Code and Safety Consultant to NEII

Dave Bressert, Director of EHS
KONE, Inc

Louis Deloreto, Manager Safety & Environment
Otis Elevator Company

John Faure, Manger Service Department
Mitsubishi Electric & Electronics USA, Inc

David Kobasic, Director of Safety
ThyssenKrupp Elevator Company

Kent Lloyd, Owner
Abell elevator International, Inc

L.J. Fleetwood, National Safety Coordinator
Fujitec America, Inc.

Clint Mathews, Area Coodinator
Liaison from the National Elevator Industry Education
Program (NEIEP)

Robert G. Merlo
Liaison from the National Association of Elevator
Contractors (NAEC)

Ricia Hendrick, Liaison from Elevator World, Inc.

TABLE OF CONTENTS

Section 1 – General Safety	8
1.1 Employee Responsibilities	8
1.2 Additional Safety Responsibilities of the Mechanic/Mechanic-in-Charge	13
Section 2 – Safety Inspections	17
2.1 Need for Routine Safety Inspections	17
2.2 Inspecting for Hazards	17
2.3 Pre-startup Safety Survey	19
Section 3 – Personal Protective Equipment (PPE)	22
3.1 Proper Clothing	22
3.2 Eye and Face Protection	23
3.3 Occupational Head Protection	25
3.4 Occupational Foot Protection	25
3.5 Hearing Protection	26
3.6 Personal Fall Arrest Equipment	26
3.7 Hand Protection (Gloves)	27
3.8 Respiratory Protection	27
Section 4 – Fall Protection	29
4.1 Personal Fall-Arrest System	29
4.2 Guardrail Systems	33
4.3 Escalator/Moving Walk Barricades	37
4.4 Elevator Maintenance Barricades	38
Section 5 – Electrical Safety	39
5.1 General Precautions	39
Section 6 – Proper Use of Jumpers	41
6.1 Maintenance and Troubleshooting	42
6.2 Modernization and New Construction	43
6.3 Door Bypass Procedure	44
Section 7 – Lockout and Tagout	45
7.1 Procedures	45
7.2 Supervisory/Emergency Removal of Lockout/Tagout	49

7.3	Lockout/Tagout Procedures for Escalators and Moving Walks	50
Section 8	– Hoistways and Machine Rooms	51
8.1	Car Top Safety	51
8.2	Pit Safety	55
8.3	Hoistway Screening	60
8.4	Overhead Protection	61
8.5	Machine Room Safety	62
Section 9	– Tools	63
9.1	Hand Tools	63
9.2	Portable Electric Tools and Lights	64
9.3	Powder Actuated Tools	66
Section 10	– Portable Ladders/Scaffolds	67
10.1	Scaffolds	67
10.2	Portable Ladders	68
Section 11	– Working Platforms	71
11.1	Running (Moving) Platforms	71
11.2	Temporary Cars	72
11.3	False Cars and Other Devices Used in the Hoistway	72
Section 12	– Material Handling	78
12.1	Manual Handling Lifting of Material	78
12.2	Ramping and Blocking of Material	82
12.3	Hoisting and Rigging	82
12.4	Wire Rope Fastenings	88
12.5	Chain Hoists	90
12.6	Slings and Hitches	90
12.7	Crosby Lifting Guide	96
12.8	Synthetic Webbing Slings - Selection, Use and Maintenance	114
12.9	Beam Clamps	119
12.10	Manila Rope	122
12.11	Synthetic Rope	122
12.12	Knots are Weak	124

Section 13 – Welding, Cutting and Soldering	130
13.1 General Precautions	130
13.2 Acetylene, Oxygen and Other Pressurized Fuel Cylinders	132
13.3 Soldering	133
Section 14 – Hazard Communications (HAZCOM)	134
14.1 Working with Chemicals	134
14.2 Oils and Grease	136
14.3 Cleaners	137
14.4 Babbiting	138
14.5 Painting	139
14.6 Welding	140
14.7 Asbestos	140
14.8 Flammable Liquids and Solvents	141
14.9 Carbon Dust	142
14.10 Sulfuric Acid Type Batteries	142
Section 15 – Inclined Elevators	145
Section 16 – Escalators and Moving Walks	146
Section 17 – Dumbwaiters	149
Section 18 – Service and Repair Job	
Hazard Assessment	151
18.1 Instructions	151
18.2 Overview	151
18.3 General	151
18.4 Foot and Leg Protection	152
18.5 Head Protection	152
18.6 Hearing Protection	152
18.7 Eye and Face Protection	153
18.8 Respiratory Protection	153
18.9 Personal Fall Arrest System	153
18.10 Hand Protection	154
18.11 OSHA Regulations	154

18.12	Competent Person	154
18.13	Assessing Workplace Hazards	154
18.14	Training	155
Section 19	– Driving and Vehicle Safety	158
19.1	Recognizing Hazards	158
19.2	Alcohol/Drug Use	158
19.3	Safety Belts are for Everyone	158
19.4	Vehicle Maintenance	159
19.5	Communication Devices	159
Section 20	– Substance Abuse	160
Section 21	– Glossary of Terms	161
Section 22	– Appendices	167
22.1	Metric Conversion	167
22.2	Electrical	173
22.3	Timber, Beams and Planks	175
Index	179

Section 1

GENERAL SAFETY

1.1 Employee Responsibilities

You shall familiarize yourself with the safety procedures outlined throughout this safety handbook. The following safety rules shall receive special attention and are not necessarily all inclusive:

- (a) In all operations, when removing or moving any component or equipment, make sure that the effect of that activity on the entire elevator or escalator system is taken into consideration.
- (b) Employees shall not work when their ability or alertness is impaired by fatigue, intoxicating beverages, illegal or prescription or over-the-counter drugs, or any other physical or emotional cause that might expose the employee or others to injury. (See Section 20)
- (c) Practical jokes, horseplay, throwing of tools or fighting on the job are forbidden.
- (d) Weapons, explosives and illegal substances on the job are forbidden.
- (e) Mechanics arriving at a location to perform service or repairs shall alert the owner or building management and place Company-approved "Out of Service" signs on a single unit landing call buttons before any work begins. (Building management may require signature in log.)
- (f) Secure the equipment (elevators, escalators, dumbwaiters, moving walks, platform lifts and chair lifts) from the riding public when performing any adjustments or work. Ensure no one is in the car, close the doors and prevent the doors from operating while working on the elevator.
- (g) Before working on equipment, "tuck" loose-fitting clothing and confine long hair. Remove all jewelry.

- (h) When unexpected movement of the equipment presents a safety hazard while cleaning, oiling, or greasing any parts that move, the equipment shall be made inoperative by use of lockout and tagout. See Lockout and Tagout Procedure, Section 7.
- (i) The use of personal entertainment devices (radios, tape or CD players, etc.) are prohibited on all jobsites.
- (j) Communication devices should be used with caution around controllers.
- (k) If two-way radios are used, ensure your communication channels are clear so they are not interfered with by other trades. Be aware of potential delays in communications when using certain communication devices.
- (l) Do not wear tool belts or carry tools in pockets.
- (m) Keep the work area clean, discard trash in a waste container, not on the floor, etc. Notify the General Contractor or Building Manager of problems in common areas. Poor housekeeping exposes everyone to hazards.
- (n) Never use wiping cloths on or near moving and/or rotating equipment.
- (o) Oily or chemically-soaked rags shall be kept in company-approved containers, removed from the jobsite periodically and disposed of properly.
- (p) If you are required to clean the pit, car top, machine room floor or other apparatus, take precautions to avoid lacerations or punctures from sharp objects by wearing suitable work gloves and using a broom and shovel, or dust pan, to pick up debris.
- (q) Remove or bend all protruding nails.
- (r) Work areas, ramps, runways, corridors, stairwells, offices, shops and storage areas must be well-lit. Notify the responsible party and your Superintendent/Manager if lighting is inadequate.

- (s) Do not work without adequate light. If there is inadequate light, use a grounded portable light with a suitable, non-conductive or grounded lamp guard and reflector.
- (t) Do not walk up or down stairways with hands in pockets. Never run on stairs. Handrails must be provided and used. Filler boards shall be in place on unfinished stairs. Be alert for tripping hazards, especially if carrying tools or materials.
- (u) Do not run extension cords in stairwells if they will cause a tripping hazard.
- (v) Open-flame heaters shall not be used for space heating of shanties, machine rooms or pits unless proper and approved venting is provided and local codes are adhered to.
- (w) When uncoiling rope, cable or wire, do not stand within the coil.
- (x) **Never slide, swing or climb on cables, ropes or guiderails.**
- (y) Never drop objects down the hoistway. A rope shall be used to safely lower objects.
- (z) Observe and obey all safety signs. Every sign serves a purpose. They are for your safety and the safety of others. If a sign is no longer necessary, it shall be removed.
- (aa) Administer first-aid only if you have been trained to do so, and never exceed your level of training.
- (ab) Do not cleanup spilled body fluids (blood, vomit, etc.) or material with body fluids unless you have received the appropriate training and vaccinations as required by OSHA (29 CFR 1910.1030), or any applicable local regulations. If you have received training and have been offered the applicable vaccinations and personal protective equipment, then assume contamination in handling any body fluids or material potentially contaminated with body fluids. All cleanup activities shall be conducted in accordance with your company Exposure Control Plan. If you have been accidentally exposed to body fluids that

may contain bloodborne pathogens, contact your applicable company medical provider as soon as possible.

- (ac) Report every injury to your Supervisor immediately (no matter how trivial) in accordance with company policy and procedure.
- (ad) The employee shall know the hazards and safe-use procedures associated with the materials and/or chemicals the employee is using. This information is available on the Material Safety Data Sheets (MSDS) provided by the Company. See Section 14 Hazard Communications for additional information. All materials and chemicals used shall be company-approved with MSDSs sheets. Improper use could result in injury or illness.
- (ae) Some elevators may be located near operations with process hazards or work environments that may be potentially hazardous in an emergency, or as part of the customer's day-to-day operation. Such elevators may be located in petrochemical plants, oil refineries, paper mills, nuclear plants and similar facilities. In such facilities the elevator pit/hoistway may be classified and/or labeled as a permit-required confined space. Do not enter the pit/hoistway until you have consulted your Superintendent/Manager.
- (af) On modernization, when removing old material from elevator platforms, make sure counter balance is properly adjusted before proceeding.
- (ag) Rotating equipment can be dangerous. Be aware of your surroundings and be prepared for "sudden" start-up of the equipment. (See Section 7)
- (ah) When working on hydraulic power units, keep your hands and clothing clear of the pump, motor, belts and sheaves to avoid being pulled into moving parts. Never check the belt tension unless the mainline disconnect switch is in the "off" position and locked and tagged out.

Copyright© 2006 Elevator World, Inc.

- (ai) Hydraulic oil may be hot and can cause severe burns.
- (aj) Elevator safety tests shall be performed in accordance with the procedures specified in the *ASME A17.2 Guide for Inspection of Elevators, Escalators and Moving Walks, (formerly Inspector Manual for Elevators)*.
- (ak) Before equipment is placed back in service, be sure all locks and tags have been removed and account for any jumpers used. All door and safety circuits shall be tested to ensure they are operating.
- (al) Before leaving the building, if the car is returned to service, remove all “Out of Service” signs. Checkout with building management.
- (am) Do not ride or permit anyone else to ride in or on top of the car during safety and buffer tests.
- (an) Do not allow other trades to work in the hoistway above and below you.
- (ao) Never look at an electric welding arc without proper eye protection. See Section 3.2.
- (ap) Never work in the hoistway below welding or cutting operations.
- (aq) Don't work in an area where a gasoline engine is running unless properly vented. A gasoline engine gives off deadly carbon monoxide gas.
- (ar) Don't work in an area where propane heaters are used unless properly vented.
- (as) Never leave an open hoistway door unguarded. Before working on an elevator with the hoistway door open place a barrier in front of the entrance. See Section 8.
- (at) If you have to get at something that is higher than you can reach, use a ladder. See Section 10. Do not stand on overturned buckets, crates, chairs, etc.
- (au) In machine rooms be careful of tripping and head bumping hazards.
- (av) Never clean or lubricate ropes with a hand held rag.

- (aw) Never work from a hoistway divider beam.
- (ax) Ensure the building fire alarms (and other emergency alerts) can be heard. If not, make sure you are on the building emergency call list.
- (ay) **Where exposed to imminent danger, vacate the area immediately.**

1.2 Additional Safety Responsibilities of the Mechanic/Mechanic-in-Charge

The Company Assigns Each Mechanic/ Mechanic-In-Charge the Responsibility for Coordinating Jobsite Safety

The Mechanic/Mechanic-In-Charge is the Company's designated **Competent Person**. They are responsible for identifying existing and potential hazards in the surroundings, or work conditions which are unsanitary, hazardous, or dangerous to employees, and for taking prompt corrective measures to eliminate or avoid the hazard(s). On the job, the Mechanic/ Mechanic-In-Charge is the person responsible for seeing that the work is performed in accordance with the company safety policy. In fulfilling this responsibility, the Mechanic/Mechanic-In-Charge shall take all practical steps to be sure that the work is performed with due regard for safety. To keep operations safe, the following are some examples of the principle job requirements of the Mechanic/ Mechanic-In-Charge:

- (a) Ensure their Helper(s) fully understand the safety requirements and that they accept responsibility for the safety of themselves, their fellow workers, the jobsite, and equipment.
- (b) Ensure that all equipment, work areas, and access to work areas where Elevator Company work is performed are inspected for any unsafe conditions which could

Copyright© 2006 Elevator World, Inc.

- cause injuries or property damage before commencement of work.
- (c) Take steps to correct all unsafe conditions or practices that are under the control of the Company.
 - R - Recognize Hazards*
 - E - Evaluate Hazards*
 - C - Control Hazards*
 - (d) When it is the responsibility of others to correct unsafe conditions, notify those responsible, (i.e., Building Owner, Project Manager, General Contractor) verbally and/or in writing per company policy. Also notify your Superintendent/Manager that such unsafe conditions exist. Avoid the area until hazard(s) is removed.
 - (e) Whenever unsafe practices by workers of other trades are observed that could effect personal safety or property damage, immediately notify your supervisor and report such practices, verbally and in writing, maintaining a copy, to:
 - (1) the Responsible person at the jobsite and
 - (2) the Elevator Company Superintendent/Manager.
 - (f) When work must be performed or materials stored in areas accessible to the public, install proper barricades, warning signs, lights, etc.
 - (g) Keep unauthorized persons out of areas where work is being performed, or where Company material is stored.
 - (h) Be sure all employees know the hazards of the type of work to be performed. A brief explanation before starting the work may prevent an incident.
 - (i) Do not work or allow any employee to work when their ability or alertness is impaired by fatigue, intoxicating beverages, illegal or prescription drugs, or any other physical cause that might expose the employee or others to injury and notify your Superintendent/ Manager immediately.
 - (j) Maintain the Company Hazard Communication (HAZCOM)

program and Material Safety Data Sheets (MSDSs) as appropriate. (See Section 14.)

- (k) Before leaving the jobsite for meals, at quitting time, or for any other reason, determine the whereabouts of each person under your supervision.
- (l) Never allow Company equipment to be loaned to, borrowed or used by anyone other than Company personnel unless authorized by your Superintendent/Manager.
- (m) Never allow non-Company personnel or non-Company material to be carried on false cars or incomplete elevators, escalators, or moving walks unless your Superintendent/Manager's approval has been obtained.
- (n) Visually inspect all tools, ladders, hoists, personal protective equipment, etc., for defects. Tag defective equipment and remove from use and from jobsite. Return for repair or replacement. Maintain company log when required.
- (o) Conduct and document jobsite Safety Meetings (Toolbox Talks) in compliance with Company policy.
- (p) **Ensure the following items are posted as required:**
 - (1) OSHA material i.e., Federal & State posters, including copies of any citations issued at that jobsite.
 - (2) Location of first aid station and telephone for medical treatment, ambulance, fire department and police in a conspicuous place.
 - (3) Evacuation, fire and other emergency procedures are posted and meeting areas outside buildings are designated when evacuation is required.
- (q) A company-approved first-aid kit shall be on every job (construction, modernization and major repair) and kits shall be periodically checked and refilled as required.
- (r) Require Company personnel to adhere to the safety requirements contained in this Handbook and the Company's safety policies.

- (s) Notify your Superintendent/Manager or Safety Department before proceeding with any inspection by local, state or federal government agency.**

1.3 Emergency Evacuation Procedures

- (a) Upon entering any jobsite or building familiarize yourself with the emergency exit route and evacuation procedure established by management of the facility.
- (b) React immediately and do not assume any alarm is false or a test.
 - 1. Remain Calm;
 - 2. Secure equipment to protect the public if necessary;
 - 3. Do not retrieve tools or personal belongings; and
 - 4. Proceed to the designated assembly area.
- (c) Upon evacuation of the facility immediately contact your supervisor or branch office for further instruction or follow your company's defined safety program.

Section 2

SAFETY INSPECTIONS

2.1 Need for Routine Safety Inspections

Safety inspections are a must in the elevator industry and required by OSHA regulations. Such inspections shall be conducted routinely, preferably daily, looking for unsafe work practices and conditions that could injure company employees and/or the employees of others. Reasons for normal inspections include, but are not limited to:

- (a) Normal wear and tear on such items as ropes, slings, scaffold planks, hand tools and PPE. All things wear out with use, which can cause unsafe conditions.
- (b) Defects, damage and weather conditions.
- (c) Site conditions may change daily.

2.2 Inspecting for Hazards

The Competent Person on the jobsite must be aware of all potential hazards on the jobsite and take immediate corrective action. The following is a sample checklist:

- Is Company-provided information posted at jobsite (OSHA, emergency phone numbers, warning signs, etc.)?
- Is the site clean and free of debris? Are materials stored or stacked neatly and a safe distance away from your work area?
- Are Company-approved first-aid kits on the job? Are they periodically checked and refilled as required?
- Are emergency first-aid responders readily available or first-aid trained people on the job?
- Is drinking water available and container plainly marked?
- Are personnel properly wearing Company-approved personal protective equipment when exposed to possible danger (i.e., gloves, work boots/shoes, hard hats, safety harnesses, safety glasses, goggles, welding hoods, etc.)?

Copyright© 2006 Elevator World, Inc.

- Are company fire extinguishers inspected monthly, readily accessible and annual maintenance certificates up-to-date?
- Are ground fault circuit interrupters (GFCIs) available and in proper use?
- Are copies of your Company's Hazard Communication (HAZCOM) Program and MSDSs on the site?
- Are hazardous materials used (i.e., welding and cutting equipment, etc.) stored properly?
- Are required locks and tags for locking out equipment available and used properly?
- Are open decks, scaffolds, planking, etc., enclosed with approved guardrails and toeboards or are employees using approved personal fall-arrest systems?
- Are all elevator hoistways, entrances and escalator wellways properly barricaded with removable guardrails?
- Are floor openings covered or protected by OSHA compliant guardrails?
- Are all hand and power tools in safe condition and grounded or double insulated?
- Are defective tools and equipment tagged with company-approved tags and removed from use?
- Is hoisting and rigging equipment in good condition and properly rated?
- Is material handling equipment in good condition and properly rated?
- Are ladders and scaffolding in good condition and being properly used?
- Are company-approved warning signs posted where necessary?
- Do work and common areas have adequate lighting?
- Are there any site specific hazards i.e., chemical plants, refineries, etc.

- Are disconnects and controllers properly labeled?
- Does the pit have adequate guards (i.e., counterweight guards, etc.), covers, is dry, and is there safe access and egress?

2.3 Pre-startup Safety Survey

A safety survey should be conducted on all construction, modernization and major repair projects prior to starting work. The responsibility for conducting a pre-startup survey shall be determined by the company. The following is a sample of the items that should be included on a pre-startup checklist.

2.3.1 Asbestos

- Customer has identified all areas containing asbestos
- Sampling has been conducted to ensure safe atmosphere
- Precautions have been taken to avoid asbestos containing material
- Employees have been properly trained, according to level of exposure

2.3.2 Lead Paint

- Customer has identified all areas containing lead paint
- Sampling has been conducted to ensure safe atmosphere
- Precautions have been taken to avoid lead paint
- Employees have been properly trained, depending on level of exposure

2.3.3 Document Requirements

- EEO, OSHA & State Posters
- Emergency phone numbers identified (i.e. fire, hospital)
- OSHA 300 log available (if required)

2.3.4 Electrical

- Wiring labeled and grounded
- Adequate power provided in areas where needed
- High voltage adequately identified and covered
- Ground Fault Circuit Interrupters (GFCI) available

2.3.5 Fall Protection

- Type of fall protection to be used is identified
- Anchor points identified
- Barricades installed properly per handbook (removable)

2.3.6 Fire Prevention

- Fire extinguishers available
- Wood/paper products or rubbish not in pit or machine room
- Smoking/No-smoking areas identified

2.3.7 First Aid

- Location of first aid station (or kit) identified
- Trained personnel identified

2.3.8 General

- Evaluate the location of work by other trades and determine impact

2.3.9 Hazard Communication

- Chemical inventory list
- Containers properly labeled
- MSDS's readily available

2.3.10 Hoisting & Rigging

- Adequate equipment for job
- Equipment inspected and certified per manufacturer recommendations
- Capacities identified (equipment and load), ensure equipment will meet expected lifting requirements

2.3.11 Housekeeping

- General condition of work area
- Walkways clear
- Regular waste disposal schedule
- Adequate lighting

2.3.12 Ladders/Stairwells

- Access stairwells have guardrails installed
- Stairwells properly lit
- Serviceable ladders of sufficient height are available
- Extension ladders have safety feet and extend 3 ft (914 mm) above landings
- Safe access to work areas provided

2.3.13 Material Handling

- Employees are trained to operate forklifts safely and sufficient equipment is available to move material safely (forklifts, dollies, handcarts, etc.)
- Equipment in good working condition
- Staging area for material and equipment identified

2.3.14 Scaffolds

- Proper erection is supervised and inspected by Competent Person
- Locking pins installed
- Equipped with baseplates
- Tied to the structure when required
- Proper planking

2.3.15 Welding

- Adequate equipment provided (if needed)
- Area identified for proper cylinder storage
- Adequate shielding is available (if needed)
- Well ventilated area identified for welding
- Properly inspected extinguisher available

Section 3

PERSONAL PROTECTIVE EQUIPMENT (PPE)

General Requirements

Employers shall ensure that personal protective equipment (for eyes, face, head, and extremities), protective clothing, respiratory devices, protective shields and barricades, are provided, used and maintained in a sanitary and reliable condition. **All employees shall have their personal protective equipment with them at all times.**

To assist in evaluating required PPE for individual jobsites, the Job Hazard Assessment Form is to be used. See Section 18.

Employee-Owned Equipment

Where employees provide their own protective equipment, the employer shall be responsible to assure its adequacy, including proper maintenance, and sanitation of such equipment.

3.1 Proper Clothing

- (a) Do not wear shorts, tank tops or trousers with cuffs. Long-sleeve shirts are recommended.
- (b) Hand tools and other objects shall not be placed in the pockets of trousers due to the possibility of snagging on moving objects or contacting energized equipment.
- (c) Finger rings, loose jewelry and torn clothing are hazardous and shall not be worn.
- (d) When working around energized equipment, finger rings, metal-framed glasses, large belt buckles and watches shall be removed or protected to prevent contacting live components.
- (e) Personal protective equipment shall not be traded or exchanged unless sanitized.

- (f) Oil free clothing shall be worn when performing welding or cutting operations.
- (g) Never wear 100% synthetic clothing, such as polyester, especially when welding, grinding or working around an open flame. Cotton or cotton blend is recommended.

3.2 Eye and Face Protection

OSHA standards require employers to provide suitable eye and face protection.

- (a) Types of protection
 - (1) Safety glasses with side protection (used for most situations).
 - (2) Goggles (used when dust or chemical splash hazards exist).
 - (A) Welder's Goggles
Used for gas cutting and welding operations. (See filter lens chart for proper shade and number in Figure 3a.)
 - (B) Welder's Shield
Used for electric arc-welding work. Lens shade chosen as above and protected by a clear cover glass.
 - (C) Face Shields
Shall be worn when entire face needs protection, (i.e.: flying sparks; chemical splash; etc.)
- (b) Employees shall wear eye and face protection equipment when machines or operations present potential eye or face injury from physical, chemical, or radiant agents, (i.e.: grinding; drilling; chiseling; babbitting; welding; dusty and windy atmosphere; etc.)
- (c) Eye and face protection shall meet the requirements specified in American National Standards Institute, "ANSI Z87.1-1989 (R1998), Practice for Occupational and Educational Eye and Face Protection."

- (d) Eye and face protection equipment shall be kept clean and in good repair. The use of this type equipment with structural or optical defects shall be prohibited.
- (e) Protection shall meet the following minimum requirements:
 - (1) Be adequate for the hazard.
 - (2) Fit snugly.
 - (3) Not interfere with the wearer's movements.
 - (4) Be durable, easy to clean, and capable of being disinfected.
 - (5) Be kept in good repair.
- (f) The user shall be instructed regarding any limitations or precautions indicated by the manufacturer.
- (g) Non-metallic eye protection shall be worn while working on or near electrical circuits or electrical apparatus.

Figure 3a

Filter lens shade numbers for protection against Radiant Energy	
Welding Operation	Shade Number
Shielded metal-arc welding 1/16-, 3/32-, 1/8-, 5/32-inch diameter electrodes	10
Gas-shielded arc welding (nonferrous) 1/16-, 3/32-, 1/8-, 5/32-inch diameter electrodes	11
Gas-shielded arc welding (ferrous) 1/16-, 3/32-, 1/8-, 5/32-inch diameter electrodes	12
Shielded metal arc welding (ferrous) 3/16-, 7/32-, 1/4-inch diameter electrodes	12
5/16-, 3/8-inch diameter electrodes	14
Atomic hydrogen welding	10-14
Carbon-arc welding	14
Soldering	2
Torch brazing	3 or 4
Light cutting, up to 1 inch	3 or 4
Medium cutting, 1 inch to 6 inches	4 or 5
Heavy cutting, over 6 inches	5 or 6
Gas welding (light), up to 1/8-inch	4 or 5
Gas welding (medium), 1/8-inch to 1/2-inch	5 or 6
Gas welding (heavy), over 1/2-inch	6 or 8

*General Note: 1 in. = 25.4 mm

- (h) **Tinted (except yellow) and shaded eye protection shall not be worn indoors except for welding and cutting operations.**
- (i) Contact lenses are not recommended at work.

3.3 Occupational Head Protection

OSHA standards require employers to provide suitable head protection.

- (a) Employees working in areas where there is a possible danger of head injury from impact, falling or flying objects, or from electric shock and burns shall be protected by hard hats.
- (b) Hard hats are to be worn at all times during all phases of construction.
- (c) Hard hats shall be worn with the suspension properly fitted.
- (d) Before using your hard hat, inspect it for cracks, etc.
- (e) Don't store hard hat where it is exposed to direct sunlight.

3.4 Occupational Foot Protection

Employers shall assess their employees' needs based on the type of work they perform to determine the proper work shoe for each employee. Work shoes purchased after June 1, 2006, shall meet ASTM F2412-05 and ASTM F2413-05. In addition Personal Protection-Protective Footwear shall conform to the following requirements:

- (a) Leather uppers
- (b) Oil resistant soles
- (c) Class 75 for impact and compression protection; where protective toe caps are required.
- (d) Employees working around live electrical equipment shall have electrically rated soles (EH rating).

3.5 Hearing Protection

OSHA standards require employers to provide suitable hearing protection. Hearing protection will be provided and used whenever it is not feasible to reduce the noise levels or duration of exposure below 85 dB on a time-weighted average.

- (a) There is no cure for noise-induced hearing loss.
- (b) Clean non-disposable earplugs after each use.
- (c) Earmuffs need to make a perfect seal around the ear to be effective.
- (d) For extremely noisy situations, wear earplugs and earmuffs.

As a rule of thumb if you must raise your voice to speak to others at a distance of 5 ft (1.5 m) or less - hearing protection should be worn.

3.6 Personal Fall Arrest Equipment

OSHA standards require employers to provide suitable fall arrest equipment.

- (a) Personal fall arrest equipment shall be worn and lanyards attached to lifelines at all times when working in or within 6 ft (1.8 m) of an open hoistway where there is the potential to fall more than 6 ft (1.8 m).
- (b) Personal fall arrest equipment shall be used only for employee safeguarding.
- (c) Any lifeline, harness, anchor, or lanyard actually subjected to shock loading, as distinguished from static loading, shall be immediately removed from service and shall not be used again for employee safeguarding.
- (d) Lifelines shall be secured above the point of operation to an anchorage or structural member capable of supporting a minimum dead weight of 5,000 lb (2268 kg).
- (e) Each employee is to be properly trained on the proper use, maintenance and inspection of personal fall arrest systems.

- (f) Lanyards shall be attached to lifeline or suitable anchorage such that an employee cannot free fall more than 6 ft (1.8 m), exceed calculated forces, nor contact any lower level.
- (g) See Section 4 on Fall Protection.

3.7 Hand Protection (Gloves)

- (a) Gloves shall be worn when potential hazards exist that could cause injuries to the hands, (i.e.: cuts; abrasions; burns; hazardous chemical exposure; etc.).
- (b) Gloves SHALL NOT be worn when working near moving machinery.

3.8 Respiratory Protection

To control those occupational diseases caused by breathing air contaminated with harmful dusts, fogs, fumes, mists, gases, smokes, sprays, or vapors, the primary objective shall be to eliminate the atmospheric contamination. This shall be accomplished as far as feasible by accepted engineering control measures (for example, enclosure or confinement of the operation, general and local ventilation, and substitution of less toxic materials). When effective engineering controls are not feasible, appropriate respirators shall be used or completely avoid area depending on company policy.

If approved by the company, NIOSH approved dust respirators (non-sealing) can be used without the following requirements as long as the employee has no known medical condition which would put them at risk (i.e., heart condition, respiratory difficulties, etc.) and the mask is discarded when contaminated.

- (a) Only physically qualified employees will be trained and authorized to use respirators. A pre-authorization and annual certification by a physician will be required and maintained.

- (b) Any changes in an employees' health or physical characteristics which may affect their ability to wear a respirator (i.e., 20% weight gain or loss, heart condition, respiratory problems, etc.) shall be reported to their supervisor and will be evaluated by a physician.
- (c) Only authorized and trained employees shall use respirators. Those employees may use only the respirator that they have been trained on and properly fitted to use. The training is required initially and shall reoccur annually. This training shall include:
 - (1) How to select the proper type of respirator and/or cartridge.
 - (2) How to inspect and maintain the respirator.
 - (3) How and when to use the respirator.
 - (4) Limitations and capabilities of the respirator.
- (d) Before an employee is required to use any respirator, the employee shall be clean shaven where the respirator meets the face, fit tested with the same make, model, style, and size of respirator that will be used on the job. The fit testing is required initially and shall reoccur annually.

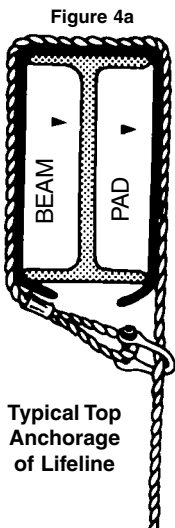
Section 4 FALL PROTECTION

General Requirements

Fall protection is required when a worker is exposed to a fall hazard (working more than 6 ft (1.8 m) above a lower level and an opening more than 12 in. (305 mm)).

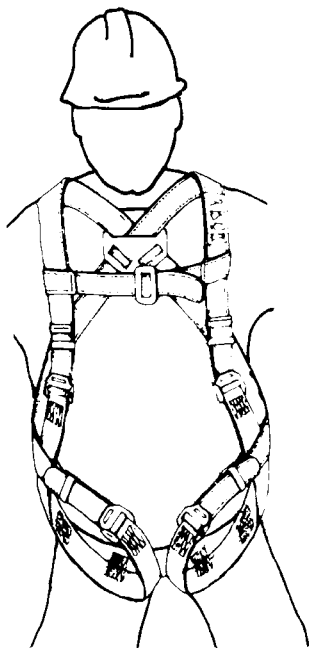
4.1 Personal Fall-Arrest System

Figure 4b shows the attachment of the body harness and shock-absorbing lanyard to the lifeline while working in the hoistway/wellway, and an example of typical top anchorage of the lifeline is shown in Figure 4a.



- (a) Only company-approved lifelines, shock-absorbing lanyards and body harnesses shall be used.
- (b) All fall protection components shall be compatible.
- (c) Lifelines shall be protected against being cut or abraded. Only synthetic or wire rope shall be used for lifelines.
- (d) Lifelines shall be installed before working in the hoistway/wellway and shall run the full length of the hoist way/wellway and be so arranged to permit tying off before entering the hoistway/wellway. Prior to use the personal fall-arrest system shall be approved by a **Competent Person**.
- (e) Only one worker is permitted on a vertical lifeline, and that lifeline shall have a breaking strength greater than 5000 lbs (2268 kg) after it has been attached to the anchorage point.

Figure 4b



Full-Body Harness



- (f) Shock-absorbing lanyards shall be anchored to the lifeline and shall be above shoulder height so that any fall shall not exceed 6 ft (1.8 m). Lanyards shall be connected to a vertical lifeline by means of a rope grab; the lanyard shall not be attached directly to the lifeline. Lifelines, harnesses and shock-absorbing lanyards subjected to impact loading shall be immediately removed from service. They shall be eliminated and destroyed for employee safeguarding.
- (g) Tying to the hoist line is prohibited. Proper rope grab shall be used.
- (h) A personal fall-arrest system shall be used on top of a completed, operational elevator car where there is a fall hazard and the car is secured from movement (locked & tagged).
- (i) On a completed car secured from movement (locked out/tagged out), tie off when exposed to a fall hazard. Do not position yourself where there is fall hazard.
- (j) Replace personal fall protection equipment at intervals recommended by the manufacturer.
- (k) Before using a body harness, shock-absorbing lanyard and lifeline, inspect them carefully each time for signs of wear or damage.

4.1.1 Inspection and Maintenance Checklist

To maintain service life and high performance, personal fall arrest systems shall be inspected before each use. Replace the personal fall arrest system if any defective conditions are found.

- Webbing.*** Grasp the webbing with your hands 6 in. (150 mm) to 8 in. (200 mm) apart. Bend the webbing in an inverted “U”. The resulting surface tension makes damaged fibers or cuts easier to see. Follow this procedure the entire length of the webbing, inspecting both sides of each strap. Watch for frayed edges, broken fibers, pulled stitches, cuts, burns and chemical damage.

- ❑ *D-Rings/Back Pads.* Check D-rings for distortion, cracks, breaks, and rough or sharp edges. The D-ring should pivot freely. D-ring back pads should also be inspected for damage.
- ❑ *Attachment of Buckles.* Attachments of buckles and D-rings should be given special attention. Note any unusual wear frayed or cut fibers or distortion the buckles or D-rings.
- ❑ *Tongue/Grommets.* The tongue receives heavy wear from repeated buckling and unbuckling. Inspect for loose, distorted or broken grommets. Webbing shall not have additional punched holes.
- ❑ *Tongue Buckle.* Buckle tongues shall be free of distortion in shape and motion. They should overlap the buckle frame and move freely back and forth in their socket. The roller shall turn freely on the frame. Check for distortion or sharp edges.
- ❑ *Friction and Mating Buckles.* Inspect the buckle for distortion. The outer bars and center bars must be straight. Pay special attention to corners and attachment points of the center bar.

Visual Indications of Damage to Webbing and Rope. The following indications refer to nylon and polyester webbing:

- ❑ *Heat.* In excessive heat, webbing becomes brittle and has a shriveled brownish appearance. Fibers will break when flexed. Harnesses made of these materials should not be used at temperatures above 180 degrees Fahrenheit.
- ❑ *Chemical.* Changes in color usually appearing as a brownish smear or smudge. Transverse cracks appear when bent over a mandrel. Loss of elasticity.
- ❑ *Molten Metal or Flame.* Webbing strands fuse together. Hard shiny spots appear. Hard and brittle feel.
- ❑ *Paint and Solvents.* Paint that penetrates and dries restricts movement of fibers. Drying agents and solvents in some paints cause chemical damage.

4.2 Guardrail Systems

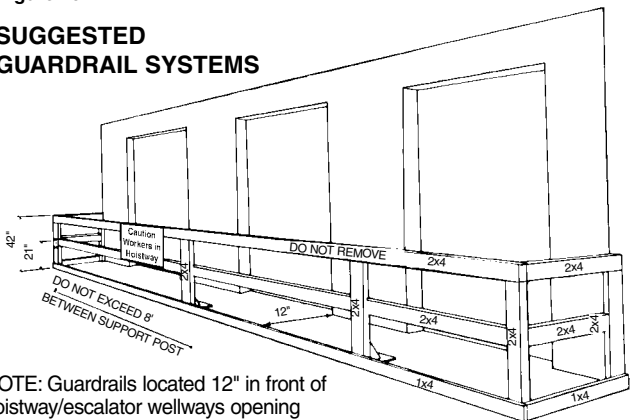
- (a) OSHA compliant removable guardrail systems with toeboards shall be installed at elevator hoistways or escalator wellways typically by the General Contractor, after either rough or finished floors are in place.
- (b) Signs shall be installed warning against removal. It is also recommended that a sign indicate "Caution: Workers in Hoistway."
- (c) OSHA compliant guardrail systems for open hoistways or escalator wellways shall have a top rail 42 in. ± 3 in. (1067 mm ± 76 mm) high, with a mid-rail 21 in. (533 mm) high at centerline and toeboards. 3-1/2 in. (102 mm) high, with no greater than 8 ft (2.4 m) between uprights and shall be capable of sustaining a force equal to 200 lbf (890 N) at the toprail, 150 lbf (667 N) at the midrail, and 50 lbf (222 N) at the toeboard. When 200 lbf (890 N) is applied, the top rail shall not deflect lower than 39 in. (991 mm). Hoistway barricades shall be so constructed that some part is removable to permit access without disassembling.
- (d) After hoistways are enclosed, and before permanent doors are installed, openings shall be protected by removable guardrail systems (including toeboards).
- (e) If it is necessary to remove the guardrails, be sure to replace them before leaving the area.
- (f) Wire-rope guardrail systems are not recommended for guarding hoistways. Where used, post spacing shall not be greater than 8 ft (2.4 m) and they shall not deflect to a height less than 39 in. above the walking/ working level when a force of 200 lbf (890 N) is applied. Warning flags shall be attached every 6 ft (1.8 m), toeboards shall be provided and they must be easily removable for access to the hoistway at the terminal landings.

- (g) If guardrails are not properly maintained in place, notify your Superintendent/Manager and the General Contractor's Superintendent immediately.
- (h) On new installation, modernization, or major repair jobs where the general public is present, solid barricades at least 8 ft (2.4 m) high shall be used to fully enclose the work areas, open hoistways and escalator wellways. They shall be properly secured to avoid unauthorized access.
- (i) When a guardrail is removed to perform a job, a personal fall-arrest system must be utilized when a fall hazard is present.

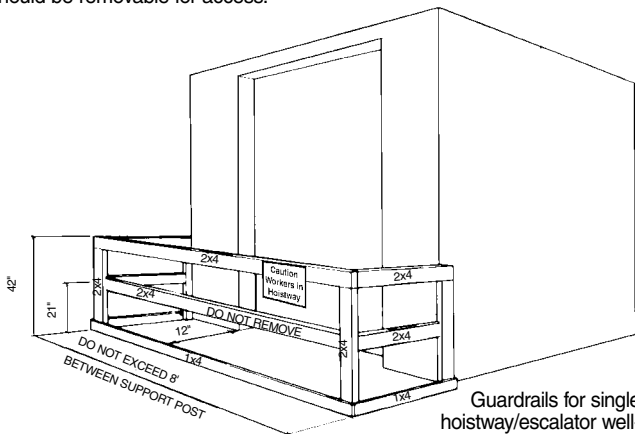
NOTE: The methods shown in Figures 4c and 4d are recommended as a means of providing maximum protection and flexibility during construction. Do not use during modernization or major repair jobs where the general public is present – use only solid barricades.

Figure 4c

SUGGESTED GUARDRAIL SYSTEMS



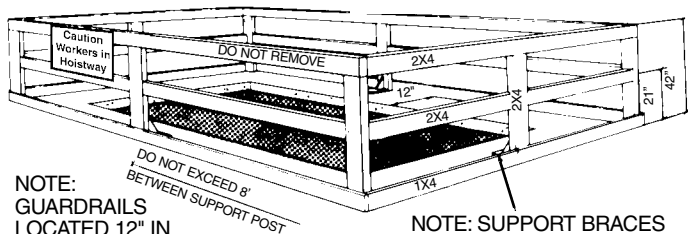
NOTE: Guardrails located 12" in front of hoistway/escalator wellways opening and flush with side walls. One part should be removable for access.



Guardrails for single hoistway/escalator wellways opening located 12" from opening

Figure 4d

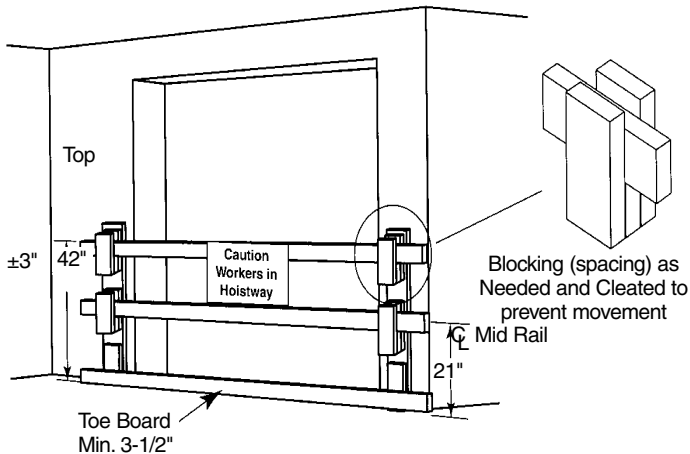
SUGGESTED GUARDRAIL SYSTEMS



NOTE:
GUARDRAILS
LOCATED 12" IN
FRONT OF HOISTWAY/
ESCALATOR WELLWAY
OPENING

NOTE: SUPPORT BRACES
TO BE MOUNTED AT EACH
SUPPORT POST

SHADED AREA ABOVE REPRESENTS CLEAR
HOISTWAY/ESCALATOR WELLWAY OPENING

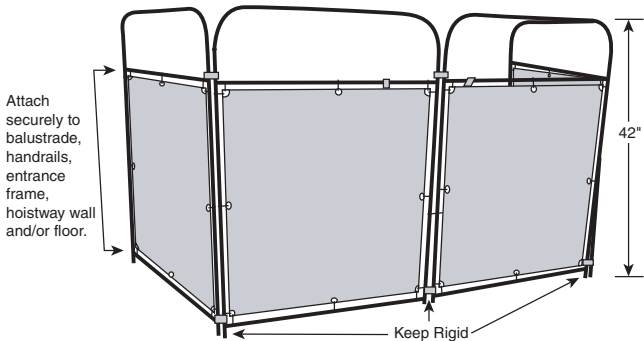


Removable Guardrails:
Space out from walls to permit Entrance Frame Installation.

4.3 Escalator/Moving Walk Barricades

- (a) Barricades shall be positioned to completely surround the escalator/moving walk from public access.
- (b) Barricades shall be positioned to surround, from public access, floor opening created when equipment access plate(s) are removed.
- (c) Barricades shall be a minimum of 42 in. (1067 mm) high.
- (d) Barricades shall be securely attached to the balustrades, handrails and/or floor.
- (e) All sections shall be connected.
- (f) A system shall be in place to keep the barricade rigid.
- (g) See figure 4e.

Figure 4e



Barricade

4.4 Elevator Maintenance Barricades

- (a) Barricade shall be positioned to restrict public access to the hoistway where doors are open greater than 5 in. (125 mm).
- (b) Barricade shall be a minimum of 42 in. (1067 mm) high.
- (c) Barricade shall be securely attached to the entrance frame, hoistway wall and/or floor.
- (d) All sections shall be connected.
- (e) A system shall be in place to keep the barricade rigid.
- (f) See Figure 4e.

Section 5

ELECTRICAL SAFETY

5.1 General Precautions

- (a) When power is not required to perform the task, lockout/tagout procedures must be followed. Testing and troubleshooting may be done live, but repairs can only be done when system has been properly de-energized or circuits isolated.
- (b) THE FOLLOWING PERSONAL PROTECTIVE EQUIPMENT SHALL BE WORN WHEN TROUBLESHOOTING LIVE ELECTRICAL CIRCUITS:
 - Long-sleeved natural-fiber or FR-rated shirts and pants, long-sleeved FR-rated coveralls or other company-approved arc-flash-hazard protection
 - Nonconductive safety glasses
 - EH-rated footwear or rubber mats
 - Clean leather gloves
- (c) Always use a circuit tester on each circuit before troubleshooting on it because all voltages can be dangerous. Contact with even low voltages can result in serious injury.
- (d) All circuits shall always be treated as LIVE unless tests prove otherwise.
- (e) Before troubleshooting any electrical circuits or apparatus, remove all jewelry, keyrings, cell phones, radios, pagers and other metal objects, etc.
- (f) Never troubleshoot circuits when standing or kneeling on metal, wet surfaces or in water.
- (g) When troubleshooting live circuits, take care to be safely isolated (i.e., rubber mats, isolated tools, EH rated shoes, etc.).
- (h) To prevent shocks, take precautions to:
 - (1) Keep metal objects from touching or being exposed to any LIVE parts, moving machine parts or connections.

Copyright© 2006 Elevator World, Inc.

- (2) Do not wear tool belts and do not carry tools in your pockets.
- (i) Use only double-insulated rated tools when troubleshooting on circuits that may not be de-energized.
- (j) While troubleshooting on MG Sets, elevator motors and solid-state motor drives, take extreme precaution, because the armature voltage present may be as high as 600 volts.
- (k) Exercise caution (Be cognizant and prepared to test other circuits that may be "LIVE") when troubleshooting on multi-car operations especially in group systems, which may have circuits that are LIVE. Even when the mainline disconnect switch is OFF, other circuits may be powered from other sources (group controls, cab lighting, etc.)
- (l) **Always** use fuse pullers to remove and install fuses. Fuses and fuse holders should be marked for proper size and type. Never use a higher amperage fuse, a fuse of a different type or bridge a fuse.
- (m) Use nonconductive flashlights.
- (n) Temporary wiring can be hazardous. All temporary wiring shall comply with the National Electrical Code, Article 305. But when temporary wiring is used, locate wiring in such a manner that no one can trip over it. Do not run temporary wiring through floors, doors or wall openings, take precautions to protect it from sharp edges and mechanical damage and do not support it with nails or wires.
- (o) All 110-volt, 15- or 20-amp circuits shall be grounded, except temporary lighting circuits. Do not wire outlet receptacles into lighting circuits unless they are grounded.
- (p) Never troubleshoot on live circuits unless necessary to perform task. See Section 7 Lock-out/Tag-out.
- (q) Always replace covers on electrical equipment after troubleshooting is completed.
- (r) **DO NOT OPEN THE MAINLINE DISCONNECT SWITCH COVER**, unless authorized by the elevator com-

pany, properly trained and appropriate PPE is worn. If power is not being supplied to the elevator controller (e.g. open mainline fuses, etc.), advise the building owner to correct the condition. This is not the elevator company's responsibility.

- (s) Keep electric cabinet doors closed when system is energized, whenever possible.
- (t) A ground fault circuit interrupter (GFCI) is required when using portable power tools and drop lights. GFCIs should be tested prior to each use.

5.2 Meter Usage Safety Checklist

- Use Category III multimeters.
- Follow the manufacturer's safety procedures for the meter used.
- Be certain the meter is in good operating condition. Notify your supervisor immediately if the meter is damaged.
- The meter used must meet accepted safety standards for the environment it will be used in.
- Use a meter with fused current inputs and be sure to check the fuses before taking measurements.
- Inspect test leads for physical damage before making measurements. If damaged, replace them before proceeding.
- Use the meter to check continuity of the test leads.
- Use only test leads that have shrouded connectors and finger guards.
- Use only meters with recessed input jacks.
- Select the proper function and range for your measurement and double check before proceeding.
- Be aware of high-current and high-voltage situations and use the appropriate equipment, such as high-voltage probes and high-current clamps.
- Always disconnect the "hot" (red) test lead first.
- Use a meter that has overload protection on the ohm function.

- When measuring current without a current clamp, turn the power off before connecting into the circuit.

5.3 Energized Circuit Troubleshooting Checklist

Work on de-energized circuits and use lockout/tagout procedures whenever possible.

- (a) On live circuits, use personal protective equipment (PPE).
 - Use insulated tools.
 - Wear nonconductive safety glasses or a face shield.
 - Wear clean leather gloves.
 - Remove watches, jewelry or other metal objects.
 - Stand on an insulated mat or use safety shoes with electrically rated soles.
 - Wear long-sleeved natural-fiber or FR-rated shirts and pants, long-sleeved FR-rated coveralls or other company-approved arc-flash-hazard protection. (Check with your company procedures for specific uniform requirements.)
- (b) When taking measurements on live circuits:
 - Hook on the ground clip first, and then make contact with the hot lead. Remove the hot lead first and the ground lead last.
 - Hang or rest the meter if possible. Try to avoid holding it in your hands to minimize personal exposure to the effects of transients.
 - Use the three-point test method, especially when checking to see if a circuit is dead. First, test a known live circuit. Second, test the target circuit. Third, test the live circuit again. This verifies that your meter worked properly before and after the measurement.
 - Use the old electrician's trick of keeping one hand in your pocket. This lessens the chance of a closed circuit across your chest and through your heart.

Section 6

PROPER USE OF JUMPERS

- (a) It is recognized that temporary circuit jumpers or clips (jumpers) may be required for conducting some service work on elevators, escalators or moving walks. All field personnel shall be trained in the proper use of jumpers for defeating safety circuits. When jumpers are used they shall have the following characteristics:
 - (1) Extra-long, tied in knots, and brightly colored wires or clips.
 - (2) Jumpers shall be numbered in sequence.
 - (3) The ends of jumper wires shall be affixed with insulated alligator clips.
 - (4) Each employee shall have his/her name or personnel number marked in indelible ink on a label permanently attached to each jumper.
- (b) Make sure you understand what effect using or removing a jumper will have on the entire elevator or escalator system prior to use.
- (c) Jumper wires shall never be placed or configured to resemble permanent wiring.
- (d) The number of jumpers carried shall be limited so that all jumpers can be accounted for at all times (numbering jumpers in sequence will help). Jumpers shall be removed and accounted for when returning equipment to service.
- (e) Equipment shall never be returned to service with jumpers left on. Equipment found in this condition shall be reported to your Superintendent/Manager immediately.

6.1 Maintenance and Troubleshooting

6.1.1 Rules

- (a) Jumpers shall not be used as a diagnostic tool. Always use a meter to troubleshoot circuits.
- (b) Temporary bridging (e.g., tomahawk) devices shall not be used to short out hall door contacts.
- (c) Do not jump out door and gate at the same time.
NOTE: You may deviate from this requirement only when a second qualified person is on site and in direct communication. **USE EXTREME CAUTION WHEN THESE CIRCUITS ARE JUMPED OUT.**
- (d) Ensure that elevator is on inspection before placing jumpers on door, gate, or safety circuits. Make a visual inspection that all hoistway doors are mechanically closed.
- (e) **Ensure all jumpers are removed before placing equipment back in service.**

6.1.2 Procedures for Jumper Use

- (a) Remove elevator from public use and ensure no passengers are in the elevator.
- (b) Place jumper kit on machine room door handle or other conspicuous place.
- (c) Verbally communicate to all other elevator personnel on the jobsite when jumper(s) are to be used. This communication provides needed information on circuits bypassed and equipment affected.
- (d) When work is complete, all jumpers shall be removed, counted and returned to the jumper kit.
- (e) Never leave jumpers on equipment or in the machine room.

6.2 Modernization and New Construction

On modernization and construction many jumpers are used to operate elevators.

- (a) Jumpers shall be brightly colored, easily identifiable and shall be long and conspicuous.
- (b) A Jumper Log shall be established to ensure that affected personnel are aware of the safety circuits which are not functioning. It is the responsibility of the mechanic/mechanic in charge to ensure that the Jumper Log is completed. The Jumper Log shall be kept with the controller and shall not be removed until all jumpers are removed.
- (c) Door, gate, or other safety circuits shall never be jumped out unless car is on inspection in the controller.
- (d) Jumpers shall be removed as soon as they are no longer needed, maintenance and troubleshooting procedures outlined above shall be followed.

In addition to the above, stickers shall be placed in the controller cabinet, in close proximity to the inspection/automatic switches, which read as follows:

<p>DOOR, GATE OR SAFETY CIRCUITS SHALL NEVER BE JUMPED OUT UNLESS CAR IS ON INSPECTION IN THE CONTROLLER.</p>
--

Before moving car with open doors, verify car is on inspection.

6.3 Door Bypass Procedure

- (a) Inspection operation with open door circuits (ASME A17.1, Requirement 2.26.1.5) shall only be utilized when it is necessary to move an elevator when the car gate and/or door lock circuit is electrically open. Before utilizing this, steps shall be taken to identify the problem circuit (car gate or door lock) and bypass only that circuit. Once a decision is made to utilize door bypass circuitry, the elevator shall be placed on inspection operation via the car top or the in-car inspection switches. Once on inspection operation, the pertinent switch(es) can be switched to “bypass” position. Then, whenever possible, the elevator shall always be operated from the top of the car.
- (b) Extreme caution shall be taken prior to and while moving the elevator to ensure the safety of the public and elevator personnel, i.e., unprotected openings, body parts clear of moving equipment, equipment unobstructed, etc.
- (c) Once the purpose for using the door bypass circuitry has been met, the switch(es) are to be switched to the “open” position. A thorough check of the car gate/door lock circuitry shall then be performed to ensure proper operation. Once this is confirmed, the elevator shall be placed back on automatic operation and returned to service.

Section 7

LOCKOUT AND TAGOUT

General Requirements

The procedures outlined below are intended to prevent injury or death to employees by requiring certain procedures be taken before working on equipment. Unless it is not feasible (i.e., inspecting, troubleshooting, observing, etc.), employees shall not perform any work on equipment where there is a potential to be exposed to energized mechanical or electrical hazards until all sources of energy have been de-energized, grounded or guarded.

Equipment variations require the mechanic to know what car controls are available and operating; the mechanic must know what safety methods will be employed to gain control of the car. Never access the hoistway unless you have control of the car.

All forms of potential energy including electrical, mechanical, hydraulic, pneumatic, kinetic, gravity, etc. shall be controlled to prevent inadvertent movement of a unit or piece of equipment being worked on.

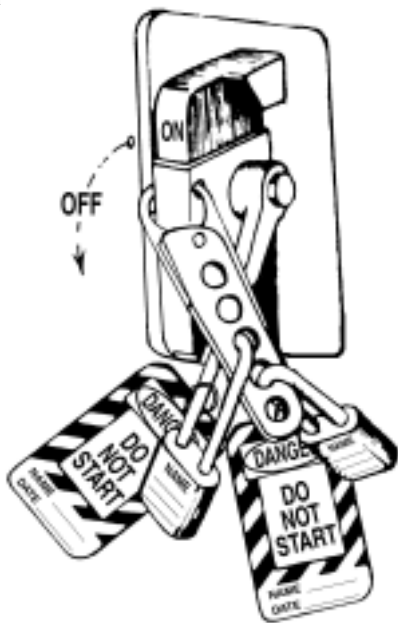
7.1 Procedures

- (a) Understand the equipment; be aware of its potential hazards. If it is not understood, or if you have a question, contact your Superintendent/Manager immediately before proceeding.
- (b) Where the accidental starting of the equipment would create a hazard – open the mainline power disconnect switch to shut off the power. **CAUTION:** Do not stand directly in front of the mainline disconnect when operating (**stand off to the side of the disconnect**). Each employee shall apply to the disconnect switch a personal lock and a “Do Not Start” tag with the employee’s name (Section 5.3).

Copyright© 2006 Elevator World, Inc.

- (c) Some components (capacitors, MG sets, etc.) often store residual energy, even though power is shut off. The stored energy can result in electrical shock or unintended movement of equipment. Before working on equipment with these components, discharge the stored energy to ground.
- (d) When it is impossible to lock the switch, assurances shall be made that the circuit is deactivated and tagged out.

Figure 7a



- (e) **CAUTION:** It is possible to have electrical energy on a controller that has had the mainline-disconnect switch opened. After initiating lockout and tagout, the lighting circuit may still be energized.
- (f) Once the system has been locked out, verify with the appropriate test equipment that the system has been de-energized. (see Section 5.3)
- (g) Before working on mechanical systems, make sure the system is understood. If there are any questions, get answers before proceeding. Such systems often store energy, even though the electrical power is shut off. The stored energy can result in violent movement of a machine part, such as a plunger or piston rod, when work is done on another portion of the equipment. If the portion of the system to be worked on can be isolated and the pressure in that portion of the system released by bleeding, it is not necessary to shut down the entire system. However, the valves and controls which could readmit pressure to the system being worked on shall be identified with "Do Not Start" tags and locked out. If a lockout is not possible, other positive action shall be taken to ensure that the equipment will not be energized. Check flanged connections, cylinder heads or plate-mounted components. The sticking of a gasket can hold the parts together, while bolts are removed, and then can come apart violently due to stored pressure.
- (h) When working under a hydraulic elevator, devices such as jacks, pipe stands, etc. shall be installed to prevent the elevator from injuring workers in the pit.
- (i) Each employee who performs duties described above will be provided with an individually keyed or combination lockout device and tags. If more than one employee is assigned to a task, each employee shall be responsible for placing their own lock and "Do Not Start" tag, so the controls cannot be operated.

Copyright© 2006 Elevator World, Inc.

- (j) If controls are so located that only one lock can be accommodated, a multiple lockout device shall be used.
- (k) Lockout devices shall be made available for locking out additional equipment.
- (l) Where special devices are required to lockout circuit breakers, they shall be available and used.
- (m) Lockout devices shall be returned to the Company when an employee transfers to other assignments or terminates.
- (n) When switches are opened for service, repairs or alterations, they shall be locked out and tagged out.
- (o) Before starting work on any equipment that is out of service, make a thorough check of all electrical control and starting devices. When any part of such equipment is remotely controlled, lockout and tagout the mainline disconnect and confirm that the system is de-energized [Section 7.1(f)].

7.1.1 Shift Changes

- (a) When employees are ending their shift and/or other employees will continue work on the machine or equipment, the employees shall attach the company locks and tags and then shall remove their personal locks and tags.
- (b) The new shift employees shall apply their personal locks and tags before beginning work on the machine or equipment. After the employees have placed their personal lockout mechanism and tag, and have verified that the system is de-energized the company locks and tags shall be removed.

7.1.2 Restoring Equipment and Machines to Normal Service

- (a) All tools shall be removed, all guards and covers shall be reinstalled and the area shall be checked to insure that no personnel are exposed to the equipment or machine.

- (b) The mechanic, after checking to make sure that no one is exposed to the equipment or machine, shall restore energy to it.
- (c) After each portion of the work is completed, the individual who places the lockout mechanism shall be responsible for its removal. If more than one operation is performed on a piece of equipment, machine or system, it will be necessary for each individual to remove their lockout mechanism immediately after their work task has ended. The last individual to remove their lockout mechanism shall notify the customer that all work has ended.
- (d) The unit shall be operated in the normal mode before returning it to service.
- (e) Remove out of service tags.
- (f) Notify the customer that the unit is back in service.

7.2 Supervisory/Emergency Removal of Lockout/Tagout

- (a) If it is necessary to operate a piece of equipment which is locked out, every effort shall be made to locate the employee whose lock is on the equipment. If the employee cannot be located, and after positive assurance is made that no one is working on the locked out equipment, your Superintendent/Manager may personally remove the lock. The Superintendent/ Manager must remember that there is danger of the employee involved returning, thinking the machine is still locked out, when actually it has been reactivated. The Superintendent/Manager shall ensure that the equipment is, once again, locked out before the employee resumes work.

- (b) If a machine is locked out and it becomes necessary to leave, recheck upon returning to make sure the machine is still locked out. While supervisors will make every effort to avoid removing locks, there may be situations when it must be done. The recheck is for your protection.

7.3 Lockout/Tagout Procedures for Escalators and Moving Walks

- (a) The applicable procedures in Sections 7.1 and 7.2 apply to all employees who work on escalators and moving walks. Anytime work is to be performed within the interior plane of the steps/ pallets, it shall be locked out and tagged out to prevent the unit from starting unexpectedly.
- (b) When it is necessary to perform work on escalators or moving walks with a limited power supply, contact your Superintendent/Manager for the safe operating procedures and review “Escalator and Moving Walk Safety.”
- (c) Whenever removal of 10% of escalator steps is done, a mechanical dog shall be activated to prevent the escalator from moving. If the unit is not equipped with a mechanical dog, the drive chain must be secured to the truss braces to prevent movement in either direction. Note: More than 10% of the steps may be removed without the use of a mechanical blocking device when company procedures document that a weight imbalance is not created.
- (d) Whenever steps are removed and the unit is going to be left out-of-service, the steps/pallets should be moved to cover the openings (whenever possible).

Section 8

HOISTWAYS AND MACHINE ROOMS

8.1 Car Top Safety

Prior to gaining access to the hoistway, determine whether power is needed to perform the required task. If not, the appropriate lockout/tagout procedure shall be used. (See Section 7.)

8.1.1 Top-of-Car Access/Egress Procedure

CAUTION: Besides examination, inspection, maintenance and adjustment work that must be done on the car top, there is a considerable amount of work in the hoistway which must be done from the top of the car and, at times with the car in motion. A few simple precautions will reduce the possible hazards.

8.1.1.1 Accessing Top-of-Car

- (a) When a hoistway access switch is provided, capture the elevator, take it to the top access landing and activate the means to disable operating devices. This means is located at the car-operating panel. With the hoistway door(s) held in the open position, activate hoistway access switch to run the car down. Stay clear of moving car.
- (b) When a hoistway access switch is not provided, capture the elevator and place two car calls to lower floors to establish a down demand. As the elevator moves away from the landing, open the hoistway door with a hoistway door unlocking device key to insure the interlock stops the elevator.

CAUTION: Do not open the hoistway door more than 6 in. (152 mm) until you determine the car top is located in a safe position to access.

CAUTION: When using hoistway door unlocking device keys be aware of pinch hazards when the hoistway door opens under power.

- (c) If hoistway access switches or hoistway door unlocking devices are not provided follow your company safety procedures for accessing the hoistway.

Copyright© 2006 Elevator World, Inc.

- (d) Prior to gaining access to the hoistway, determine whether power is needed to perform the required task. If not, the appropriate lockout/tagout procedure shall be used. (See Section 7.)
- (e) Before getting on top of the car from the landing, mechanically block the hoistway doors in the open position. Then, reach in and:
 - (1) Place the top-of-car stop switch in the “STOP” position.
 - (2) Place the inspection switch in the “INSPECT” position.
 - (3) Turn the car top work light on if you can safely reach it from the landing, otherwise: reposition the car to provide safe access to the car top.
 - (4) Before stepping onto the car top, place a hall call and allow the hoistway doors to close. If the car remains stationary for 10 seconds, open the doors, locate a safe refuge area and access the car top. (You have verified that the car will not run automatically.)

NOTE: On elevators without top-of-car inspection stations, use the proper procedures in Section 8.1.2 (j).

CAUTION: Be sure you have a surface to stand on that will support your weight. Don't stand on the car top emergency exit or fan unit, and use special care where the car tops are curved or domed.

- (5) Place the top-of-car **stop switch** in the “RUN” position and verify that up, down and enable (where provided) buttons function correctly.

CAUTION: Always be alert, and always be aware of your surroundings and the conditions where you are working.

- (e) When in a multiple hoistway, **never place any part of your body in the runway of an adjacent operational elevator.**

8.1.1.2 Exiting Top-of-Car

- (a) Position top-of-car level with the egress landing. When a hoistway access switch is provided, position the top-of-car at the landing where the top access switch is located.

- (b) Place the top-of-car stop switch in the “STOP” position.
- (c) Check for tools, keys, rags or any other equipment.
- (d) Slowly open hoistway door and place door wedge tool into the sill.
- (e) Step off top-of-car onto landing.
- (f) Place the inspection switch in the “NORMAL” position.
- (g) Place the top-of-car stop switch in the “RUN” position and turn off the car top work light.
- (h) When a hoistway access switch is provided, with the hoistway door(s) in the open position, activate hoistway access switch to run the car up. Stay clear of moving car. Deactivate the means to disable operating devices.
- (i) Remove door wedge tool and close hoistway door.
- (j) Verify elevator is operational by placing a hall call.

8.1.2 Safety precautions when working on car tops:

- (a) Familiarize yourself with the position of the car and counterweights of the car being accessed as well as any other cars/counterweights in the vicinity and take appropriate measures to keep yourself and others away from hazards.
- (b) If movement of the car is needed while on top of the car, be sure to have a firm hold on the crosshead, or other part of the car structure.
- (c) Never stand or sit on the crosshead when the car is moving.
- (d) Never hold onto the ropes, sheaves or sheave guard.
- (e) If the car top is not clean (i.e., oil, grease), clean it prior to performing any activities.
- (f) Verify proper operation of top-of-car inspection operating buttons.
- (g) Where outlets are provided, use a grounded portable light with a suitable, non-conductive or grounded lamp guard and reflector.

Copyright© 2006 Elevator World, Inc.

- (h) Electrical cords are not to be hung on car or counterweight ropes.
- (i) When a top-of-car operating device is available and operational, use it to operate the car instead of depending on an operator in the car.
- (j) If top-of-car operating device is not available and you must ride on top of the car ensure:
 - (1) The person on the car top shall identify and be positioned in a safe refuge space. Do not enter areas marked with Red and White strips.
 - (2) The operator in the car is briefed on the signals to be used.
 - (3) The operator in the car repeats instructions each time before moving the car.
 - (4) That hall buttons cannot control the car.
 - (5) The operator shall only run the car on the slowest possible speed and only in the specified direction.
 - (6) In the case of single and collective-operation elevators or any elevator whose reversal at the terminals is automatically controlled, instruct the operator to reverse the direction of the car before the terminals by means of the reversal switch in the car.
- (k) When a fall hazard exists, fall protection shall be used. (See Section 4.)
- (l) Wire ropes shall only be inspected or lubricated when the car is stopped. Avoid pinch points.
- (m) When opening hoistway doors from the car top, do so slowly so that no one steps in from the landing thinking a car has arrived.
- (n) Observe overhead clearances.
- (o) Use extra care when working on car tops that are curved, domed, or located in unenclosed hoistways.
- (p) Do not leave parts, lubricants, etc on the top of elevator cars. This is a violation of the ASME A17.1 Code.

- (q) The car top emergency exit shall remain in the closed position except when passing through same.
- (r) Before performing repairs from top-of-car, with the car at or above the top landing, place a ladder in car under top emergency exit to provide means of exiting from car top.

8.2 Pit Safety

8.2.1 General

- (a) Many serious injuries occur every year, entering and exiting pits. Every employee must be aware of the hazards before entering a pit. Some of the more common hazards are:
 - (1) Inadequate refuge space
 - (2) Inadequate lighting
 - (3) Improper access
 - (4) Tripping hazards
 - (5) Unsafe or lack of pit ladders
 - (6) Moisture/water/oil
 - (7) Moving equipment

Take appropriate steps to minimize these hazards and any others that are identified.

- (b) Before entering a pit, familiarize yourself with the position of the car and counterweights for the car being worked on as well as any other cars/counterweights in the vicinity.
- (c) Control of the car shall be obtained prior to entry into the pit.
- (d) If notified by the building owner or representative that the pit and/or hoistway has been classified as a permit required confined space (this notification could be verbal or the pit/hoistway may be labeled), immediately notify your Superintendent /Manager for further instructions. In either case, DO NOT enter the pit/hoistway until consulting your Superintendent/Manager and receiving authorization.

8.2.2 Elevator Pit Access/Egress Procedure

NOTE: These procedures do not apply to walk-in pits. See Section 8.2.3 for Walk-in Pit procedures.

8.2.2.1 Accessing Pits

- (a) When the movement of the elevator is required, the following procedure shall be followed in lieu of the Lockout/Tagout procedure in Section 7.
 - (b) Lockout/Tagout procedures are required if movement of the elevator is not needed to complete the work being performed. (See Section 7.)
 - (c) Before entering the pit, notify the building manager/owner that you will be servicing the elevator. Tag the elevator out of service by placing a sign on the controller stating "ELEVATOR IS UNDER THE CONTROL OF A SERVICE PERSON - DO NOT OPERATE."
 - (d) Install barricades if the hoistway door is going to be open more than 5 in. (125 mm) while performing your work. (See Section 4.4)
 - (e) When a hoistway access switch is provided capture the elevator at the lower access landing and activate the means to disable operating devices. This means is located at the car-operating panel. With the hoistway door(s) held in the open position, activate hoistway access switch to run the car up. Stay clear of moving car.
 - (f) When a hoistway access switch is not provided, capture the elevator and place two car calls to upper floors to establish an up demand. As the elevator moves away from the landing, open the hoistway door with a hoistway door unlocking device key to insure interlock stops the elevator.
- CAUTION: When using hoistway door unlocking device keys be aware of pinch hazard when the hoistway door opens under power.
- (g) If hoistway access switches or hoistway door unlocking devices are not provided follow your company safety procedures for accessing the hoistway.
 - (h) Before accessing the elevator pit, place a door wedge tool in the sill to ensure that the hoistway door(s) will not shut, turn the pit light on and place the pit stop switch in the "STOP" position.

- (i) If the pit does not have a pit stop switch, the lockout/tagout procedure is to be implemented before entering the elevator pit. (See Section 7.)
- (j) Standing outside the hoistway, remove door wedge tool and close the hoistway door.
- (k) Enter a hall call to verify the elevator will not run verifying the pit stop switch is working. When working on a multiple bank of elevators wait for a minimum of 20 seconds to verify the elevator you are working on will not run.
- (l) Once verification of the pit stop switch operation is complete, open the hoistway door, place a door wedge tool back into the sill, do a mental job hazard assessment and locate a safe refuge space. Do not enter areas marked with Red and White strips. Carefully enter the pit.
- (m) In deep pits a second stop switch is typically installed 4 ft above the pit floor. After descending the pit ladder place the lower pit stop switch in the “STOP” position.
- (n) If operation of the elevator is necessary:
 - (1) The car is only to be operated on inspection operation from either the car top with top-of-car inspection operation or inside the car with in-car inspection operation, if provided, by a qualified elevator person. The person operating the car and the person in the pit shall establish and maintain two-way communications.
 - (2) Install pipe stands.
 - (3) Remove the door wedge tool and allow the hoistway door to close.
 - (4) Place the upper pit stop switch in the “RUN” position.
 - (5) Stand on the pit floor and be prepared to stop the movement of the elevator with the pit stop switch.

CAUTION:

- (o) Never stand on the pit ladder when the pit stop switch at the access landing is in the “RUN” position, unless two pit stop switches are provided and the lower switch is in the “STOP” position.

- (p) When work is to be done on the hydraulic system, the car shall be landed on pipe stands, hydraulic pressure relieved and appropriate lockout/tagout procedures implemented. (See Section 7.)
- (q) When in multiple hoistways, **never place any part of your body in the runway of an adjacent operational elevator.**

8.2.2.2 Exiting Pits

- (a) Verify lower pit stop switch, where provided, is in the “STOP” position.
- (b) Verify pit stop switch at access door is in the “STOP” position.
- (c) Place lower pit stop switch in the “RUN” position.
- (d) Remove pipe stands.
- (e) Slowly open hoistway door and place a door wedge tool into the sill. Exit the pit.
- (f) Turn the pit light off.
- (g) Place the pit stop switch at access door in the “RUN” position.
- (h) When a hoistway access switch is provided, with the hoistway door(s) in the open position, activate hoistway access switch to run the car down. Stay clear of moving car. Deactivate the means to disable operating devices.
- (i) Remove door wedge tool and close hoistway door.
- (j) Place the car back into service.

8.2.3 Walk-in Pits

NOTE: See Section 8.2.2 for pit access procedure through lowest hoistway door

8.2.3.1 General guidance

- (a) Every walk-in pit is different. Therefore it is difficult to make one set of requirements that applies to all situations. For each situation that may be encountered, site specific requirements and procedures shall be established. Formulated requirements and procedures will depend on the height of

the pit (7 ft. [2.1 m] or more of overhead clearance) and the guarding or location of related components such as; tapes, governors, counterweights, traveling cables, etc.

- (b) Always wear a hard hat in walk-in pits where cars are operating.

8.2.3.2 General Rules that apply to the majority of walk-in pits.

- (a) For walk-in pits where there is no risk of being stuck by the car or related equipment:
 - (1) With elevators operating, it is generally safe to enter the pit to perform brief visual inspections, to walk from one pit to another to make observations, or to retrieve dropped items at the front side of the hoistway (e.g. keys, money, jewelry, small tools, etc.).
 - (2) For brief work activities such as minor adjustments or adding oil to buffers, the unit to be serviced must have two circuits tested and verified that the elevator will not run to ensure sufficient safe control.
 - (3) For repair work, the unit shall be locked and tagged out.
- (b) When working on elevated buffer stands (more than 6 ft. [1.8 m] off the pit floor) fall protection (guardrails or Personal Fall Protection) is required.

8.2.4 Safety precautions when working in pits:

- (a) Locate a safe refuge area and be prepared to enter same at a moment's notice.
- (b) Ensure that all portable lights and tools are connected through a Ground Fault (GFCI).
- (c) Take care to protect all lighting from damage.
- (d) Do not work in a pit with standing water.
- (e) Never "jump" into a pit – always use the access ladder or a portable ladder.
- (f) Always check your shoes for oil/grease prior to climbing.

- (g) Use both hands when using ladders entering or exiting the pit.
- (h) Be aware of moving equipment (i.e., counterweights, pumps, motors, belts, and sheaves) and ensure that clothing and hands can't get caught in them.
- (i) Avoid smoking or open flames while in the pit.
- (j) Use proper hand protection while cleaning pit.
- (k) Never place your body under the car and have the car lowered to or below the bottom landing. This does not apply to walk-in pits.
- (l) Never stand in counterweight runway, under compensating chains or straddle over the traveling cable(s) loop.
- (m) Never use wooden timbers to support car or counterweights.
- (n) Do not leave parts, lubricants, cleaning equipment, etc in the pit. This is a violation of the ASME A17.1 Code. Pipe stands may be stored in the pit.

8.2.5 Additional safety precautions to be taken when working under hydraulic units:

- (a) DO NOT stand on the hydraulic piping.
- (b) DO NOT work on the hydraulic system (i.e., repacking a jack, work on oil supply lines, pipe fittings or any portion of system that may be under pressure) unless the elevator is "landed" on pipe supports.
- (c) Avoid pinch points that a plunger or piston may present. The plunger or piston may not react normally, especially after repacking.

8.3 Hoistway Screening

Where an elevator is operating in a multiple hoistway, and construction or modernization work is to be performed in an adjacent portion of that multiple hoistway, that portion of the elevator's hoistway where the work is to be performed shall be fully separated. The material used for this separation shall:

- (a) be equal to or stronger than 0.0437 in. (1.118 mm) dia. wire;
- (b) have openings not exceeding 1 in. (25 mm);
- (c) be so supported and braced so as to not deflect into the code required running clearance of the adjacent car; and
- (d) be in accordance with local code.

8.4 Overhead Protection

- (a) Overhead protection shall be provided in the hoistway and in any other work area where there is exposure to falling objects. This protection is to prevent all parts of the body from being struck by falling tools, debris, small parts, etc.
- (b) In general, overhead protection can be achieved by *one or a combination of the following examples*:
 - (1) False cars with roofs/netting designed and selected by the company.
 - (2) Installation of an overhead barrier directly above the work area which covers all areas where field personnel have to stand or reach to install hoistway components
 - (3) Protection of all hoistway openings above the work area (e.g.: installation of hoistway doors or protective screening)
 - (4) Sealing off corridors to prevent other trades from working near or passing by wall openings
 - (5) Walls are in place and all hoistway doors closed
 - (6) Guarding all holes in the machine room and secondary levels
 - (7) Prohibiting simultaneous work in hoistway and machine room with unguarded holes
 - (8) Prohibiting simultaneous work in common hoistways where no hoistway screening exists between hoistways
 - (9) Prohibiting storage of materials within 6ft. (1.8m) of hoistway openings.

- (c) All cases where objects have fallen down the hoistway must be immediately investigated and reported by the mechanic in charge. Once the cause for this occurrence has been identified, it will be mitigated by the company or the MIC.

8.5 Machine Room Safety

Access to machine rooms, as well as working in the machine room itself, can be hazardous if proper precautions are not taken. It is very important that you have the ability to recognize potential hazards and are aware of the proper precautions to take when they exist. Machine rooms shall be secured from unauthorized access.

8.5.1 Access to the machine room

Just getting to a machine room can be hazardous, so recognizing potential hazards and taking steps to correct or avoid them is very important. Some of the more common hazards are:

- (a) Lighting
 - (1) If the stairwell or hallway area is not well lit, use a flashlight or other temporary lighting until the situation can be corrected – Don't just "feel your way" in the dark.
- (b) Unsafe ladders
 - (1) Many machine rooms can only be accessed through the use of fixed ladders. Always check the condition of the ladder before climbing.
 - (2) Never climb a ladder with tools in your hands. Use a rope to pull tools up.
- (c) Machine room doors are typically self-closing and/or self-locking. The ASME A17.1 requires the door to be operable from inside the machine room without the need to use a key.

Section 9

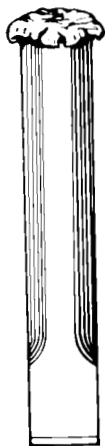
TOOLS

9.1 Hand Tools

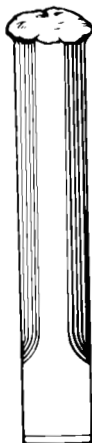
- (a) Employees shall maintain hand tools in good condition at all times.
- (b) Do not use tool belts and never carry tools in your pockets.
- (c) Never use tools that are worn, cracked or broken.
- (d) Pliers and pipe wrenches shall not be used on nuts and bolts.
- (e) Crescent wrenches shall never be used in place of the proper-type wrench.
- (f) Do not use makeshift tools such as pipe, iron bars or extensions for leverage (cheaters).
- (g) Use the correct size crowbar for each job. Place a block of wood under the head of the crowbar for leverage.
- (h) Never strike hardened steel surfaces with a steel hammer. Use a soft metal hammer or one with a plastic, wooden or rawhide head.
- (i) Cold-chisels, center-punches, etc., shall be dressed to eliminate mushrooming.
- (j) Keep a knife sharp and in a sheath or holder when carrying it on a job. Do not use it for stripping traveling cable; use cable strippers instead. When using a knife, always cut away from your body.
- (k) Avoid placing a tool box where another person may trip over it.
- (l) Split or loose handles in hammers or sledges shall be replaced with new and properly fitted handles before being used. Handles shall never be wired or taped.
- (m) Always keep screwdrivers properly dressed and their handles in good condition.

- (n) Never use a screwdriver as a punch, wedge, pinch bar, pry or chisel.
- (o) Files shall never be used unless they have a proper handle, and never as a pry.
- (p) Always use the proper tool for the job it was intended.

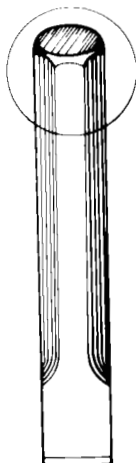
Figure 9a Use only properly dressed chisels



Wrong



Wrong



Right

9.2 Portable Electric Tools and Lights

- (a) Electrically powered tools cause the same types of incidents as hand tools, but the injuries are usually more severe.
- (b) Power tools, portable lights or cord sets shall be protected by GFCIs.
- (c) If the insulation on an electric tool or cord is broken, cracked, missing or damaged, destroy and discard the tool or cord.

- (d) Never tamper with or remove three-prong grounding plugs or pins. This eliminates the grounding protection. When grounded outlets are not available — as may be found in older buildings — adapter plugs shall be used with the grounding wire secured to a positive ground. (Note: The cover plate screw may not give a positive ground, use your meter or GFCI tester to test for positive ground.)
- (e) Always use a GFCI when plugged in even when using double insulated tools.
- (f) Double-insulated tools may be used if they are distinctively marked with the words “Double Insulated,” or the symbol shown in Figure 9b.
- (g) When using extension cords, make sure the cord is plugged into a grounded outlet of correct voltage and the cord is capable of carrying the expected load. Extension cords shall conform to OSHA Standards and be Company-approved. 110-volt extension cords shall be durably marked with the size (12-3 or 14-3 AWG) and type as noted in the chart below:

Figure 9b



Figure 9c Approved Markings for Extension Cords

Hard Service				Junior Hard Service		
S	SO	ST	SE	SJ	SJE	SJT
	SOO	STO	SEO	SJO	SJEO	SJTO
		STOO	SEOO	SJOO	SJEOO	SJTTOO

- (h) Flexible cords shall be used in continuous lengths without splice or tape. Hard service flexible cords No. 14 or larger may be repaired or spliced. The splice and insulation characteristics shall be equal or greater than the original cord.
- (i) Electric cords shall not be run through holes in walls, ceilings or floors. If run through doorways, windows, or similar openings, they shall be protected from damage.

- (j) Metal or plastic electrical boxes, commonly referred to as “handy” boxes, shall not be used to make extension cords and multipliers. Do not “field engineer” electrical components. Such components and assemblies are not approved for that use.
- (k) Portable lights shall be equipped with guards to prevent accidental contact with the bulb. Unless guards and handles are properly grounded, they shall be made from non-conductive materials.
- (l) Portable lights shall not be suspended by their electric cords, unless cords and lights are designed for this means of suspension.
- (m) Work areas, walkways and similar locations shall be kept clear of all cords so as not to create a hazard to employees or subject cords to damage.
- (n) Do not lift or lower portable electric tools by the power cord; use a handline. Never throw tools, equipment or material from one work level to another.
- (o) Keep all cords coiled when not in use. To prevent cord damage do not wrap cords tightly around tools.
- (p) Hand-held power tools shall not be equipped with a “dead man” control. It may have a lock-on control provided turn off can be accomplished by a single motion of the same finger or fingers that turn it on.
- (q) Power operated cutting tools shall have a functional brake.
- (r) Avoid forcing tools; let the tool do the work.
- (s) Unplug power when adjusting or cleaning the tool.
- (t) Never use electrical tools for purposes other than intended.
- (u) Keep guards in place and properly adjusted.
- (v) Have a firm footing and be properly braced when using power tools.

9.3 Powder Actuated Tools

Powder actuated tools are prohibited on all worksites.

Section 10

PORTABLE LADDERS /SCAFFOLDS

10.1 Scaffolds

- (a) Scaffolds shall be erected in accordance with approved safety standards under the supervision of a **Competent Person** (see Section 21).
- (b) When used, wooden or synthetic planks shall be scaffold-grade or approved by a **Qualified Person** for scaffold use capable of withstanding 4 times the working load.
- (c) The assembly and disassembly of scaffolds shall be done using a safety harness and lifeline anytime there is more than a 6 ft (1.8 m) fall exposure.
- (d) Ladders are required to reach working surfaces more than 2 ft (610mm) above or below the point of access.
- (e) In hoistways, at least two 2 in. (51 mm) by 10 in. (254 mm) planks must be used with a minimum of 6 in. (152 mm) of bearing and a maximum of 12 in. (305 mm) of overhang beyond the bearing surface. The span shall not exceed 10 ft (3.05 m) for a single plank. The planks shall be cleated to prevent movement.
- (f) No planks shall be of such length as to extend into passageways where there is a possibility of planking being bumped by the movement of people, materials or equipment through the area.
- (g) Under no circumstances shall others be permitted to use the Elevator Company's scaffolds or scaffolding materials unless approved by your Supervisor/Manager. Under no circumstances shall the elevator company use other trade scaffolds unless approved by your Supervisor/Manager.

- (h) If it is necessary to have workers below the work area, make sure cover protection is provided. A minimum of 3/4 in. (19 mm) plywood on 2 in. (51 mm) planking shall be used.
- (i) Never erect scaffolding in an active hoistway, unless the car has been completely shut down and the mainline disconnect switch locked out and tagged. (See Section 7.)
- (j) Do not climb cross braces on scaffolds.
- (k) When using tubular welded frame scaffold, the sections shall be joined together using the lock pins provided for that purpose.
- (l) Spacing between ladder rungs shall meet OSHA standards.
- (m) Scaffolds shall be equipped with baseplates.
- (n) Scaffolds shall be tied into the building with rigid connectors spaced 4 times the minimum width at intervals not exceeding 26 ft (7.9 m).
- (o) Unless the scaffold is fully planked and equipped with proper guardrails and toeboards, the employee shall be tied off using a personal fall-arrest system.

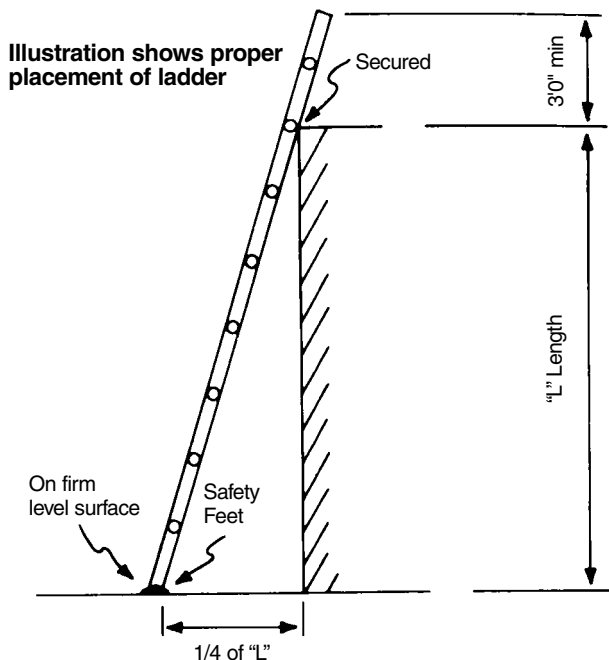
10.2 Portable Ladders

- (a) Only OSHA-compliant ladders shall be used.
- (b) Use type 1-A ladders (300-lb rating) as a minimum.
- (c) Because metal ladders are conductors of electricity, they shall not be used.
- (d) Extension ladders shall be equipped with safety feet.
- (e) Ladders shall be examined for defects before every use. Those found to be defective shall be tagged “Defective – Do Not Use” and removed from the jobsite.
- (f) Ladders shall never be painted.
- (g) No more than one person is allowed on a ladder.
- (h) Avoid reaching more than an arm’s length while working on a ladder.

- (i) Do not work from the top 3 rungs of any straight or extension ladder or top 2 steps of an A-frame ladder.
- (j) Only ladders of sufficient length shall be used. Adding makeshift extensions is dangerous and prohibited.
- (k) When ladders are used for ascending or descending from one level to another, extend the ladder top at least 3 ft (914 mm) above the landing served and tie it off, with feet secured against slippage.
- (l) Extension ladders shall be placed so that the space between the bottom of the ladder and the supporting structure is 1/4 the supported length of the ladder (see Figure 10a).
- (m) When placing and using extension ladders, care shall be taken to avoid overhead obstructions and hazards (electrical, low ceilings, pipes, etc.).
- (n) When a ladder is being used in a location where it may be struck by others in the area, there shall be a second person at the bottom of the ladder at all times. Ladders shall never be left in such locations when not in use. Whenever it is necessary to place a ladder in front of a door opening, the door shall be blocked, locked or guarded by a second person. When ladders are placed in an aisle or corridor, the area shall be barricaded or roped off.
- (o) Be aware of the potential hazard of other trades working on ladders in your immediate area.
- (p) Lift and lower large articles with a handline.
- (q) When climbing up and down, always face the ladder and maintain 3-point contact at all times.
- (r) Extension ladders shall not be taken apart to make two ladders.
- (s) Step ladders shall only be used in their fully open position with spreader or locking device engaged to prevent accidental fold-up of the ladder.

- (t) Remove tools, tool bucket and equipment from ladder before moving.
- (u) When working on a ladder, maintain three points of contact, with center of body within the rails at all times or fall protection shall be used when 6 ft. (1.8 m) or greater above the ground.

Figure 10a



Section 11

WORKING PLATFORMS

11.1 Running (Moving) Platforms

- (a) The running platform is not an elevator and shall not be used to haul other personnel or material. Any other use of a running platform shall be approved by your Superintendent/Manager. In the event that work done by another trade must be done on a running platform, it shall be done only with the permission of your Superintendent/Manager. Any movement of a running platform shall be done by Elevator Company Personnel only.
- (b) Before hoisting or roping of a platform, the governor shall be installed and roped to the safety releasing arm and tested to ensure that the safety is operational.
- (c) Fall protection should always be utilized - However, if a personal fall protection system is not utilized, the running platform shall be equipped with guardrails and toe-boards. The front of the platform shall be equipped with removable guardrails until the front of the hoistway is completely enclosed.
- (d) When required the running platform shall be counter-weighted for the weight of the car platform assembly and its expected load. Do not put all the counterweights in the frame and be sure they are secured.
- (e) Temporary run controls and cords shall be inspected daily. Damaged cord shall be destroyed and discarded.
- (f) Temporary run controls shall be three button control ("UP," "DOWN," "SAFETY") so that it takes activation of two buttons to run any direction, plus an emergency stop switch. Cords shall be fitted with strain relief and insulation shall be intact. All buttons shall function as intended.

- (g) The temporary operating station shall be mounted on the side of the car sling, away from the entrance and the counterweights. The operating station shall have a means for locking it out of service or disconnecting it to prevent unauthorized use.
- (h) Buffers shall be in place before using a running platform.
- (i) Running platform for hydraulic elevators shall never be hoisted with a chain fall or winch.

11.2 Temporary Cars

- (a) When an elevator is to be turned over to the building owner or general contractor for temporary use during construction, it shall meet all the requirements of Section 5.10 of the *ASME A17.1 Safety Code for Elevators and Escalators* and/or applicable local code. Post proper signs showing capacity in pounds (kilograms) and number of people.
- (b) The signed Temporary Acceptance Form shall show allowable capacity in pounds (kilograms) and number of passengers. If counterweight, setting of governor, or area of car platform have been altered, coordinate with your office to provide proper documentation for operation of the temporary elevator.

11.3 False Cars And Other Devices Used In The Hoistway

- (a) There are a variety of false cars and similar devices used in the hoistway to stack rails, set brackets, set hoistway entrances, run hoistway wiring, etc. Remember the following very important points at all times:
 - (1) In the event that work done by another trade must be done from a false car, it shall be done only with the permission of your Superintendent/Manager.
 - (2) Any movement of a false car shall be by Elevator Company Personnel only.

Figure 11a

FALSE CAR

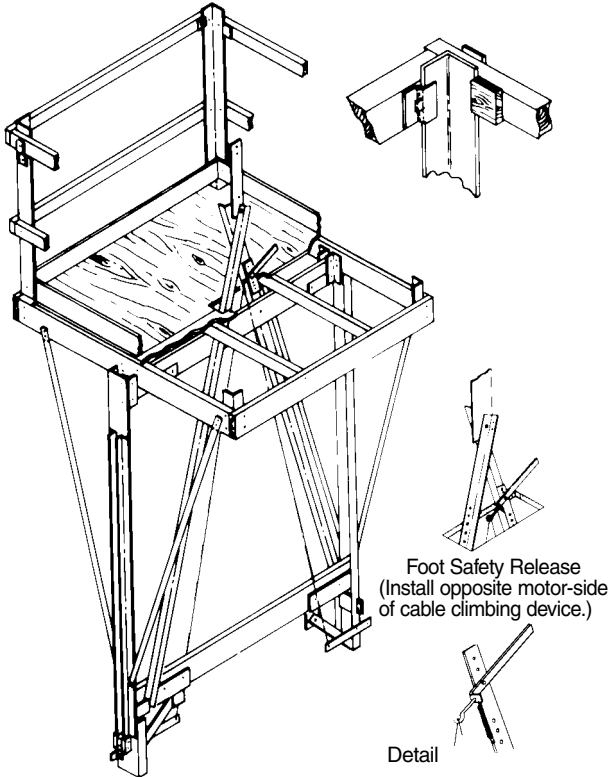
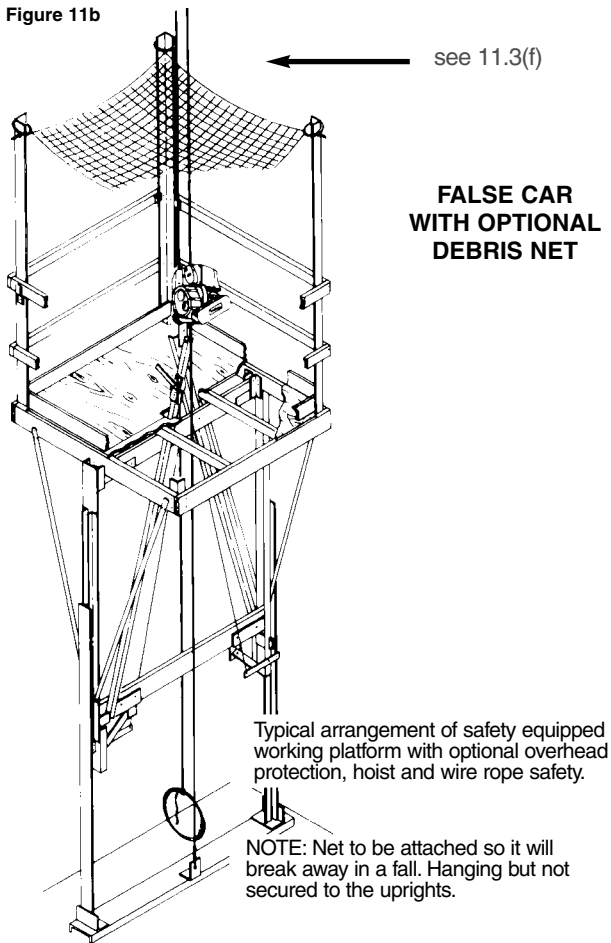


Figure 11b



- (b) This equipment is designed to move Company workers, equipment and supplies **“only”**. The maximum load on a false car shall not exceed the manufacturer’s rated load. The manufacturer’s rated load shall be posted on the equipment.
- (c) The assembly and disassembly of a false car shall be done using body harnesses, shock-absorbing lanyards and lifelines anytime there is more than a 6 ft (1.8 m) fall exposure. (See Section 3.6.)
- (d) When a false car is first placed in use on a job or moved from one hoistway to another, a safety test as detailed by Company Policy shall be performed to ensure the safeties hold the load. This test shall be documented and a file maintained as long as the false car is in use in that hoistway. A daily test shall be done on a static basis before using the car each day. The overhead supports and rigging shall be checked on a daily basis also. The safety test shall be performed at – or as close as possible to the lowest landing. It is equally important that the false car safeties be properly adjusted for the size rails on which they are being used. Never disable the safeties by tying back the safety cables.
- (e) The two sides and rear of the false car shall be provided with a guard rail system 42 in. \pm 3 in. (1067 mm \pm 76 mm) high with a midrail 21 in. (533 mm) high and toe board 3-1/2 in. (102 mm) high, conforming to OSHA requirements. Warning chains shall be installed across the front of the false car. Where working conditions are such that overhead protection is required on the car, the use of a debris net with 1/4 in. (6.4 mm) openings is recommended.
- (f) An alternative to the optional safety net is a plywood structure mounted overhead on an angle slanting to the back of the hoistway. If required, this protective structure should be hinged with a heavy grade hinge and hardware. In the case of front and rear openings the overhead protection shall be slanted to the side of any non-opposing equipment.

- (g) There are two recommended methods of moving a false car in the hoistway. The first is a cable-climbing-type device. These are available under a variety of names, such as Power Climber, Sky Climber, and Cable Climbers, etc. Each unit has some minor differences, but basically, they operate in the same manner. They climb a wire rope that has been located in the hoistway and securely fastened to the overhead support structure. The excess wire rope is normally coiled up and hung in the pit to prevent damage to it.
- (h) There shall be a safety line (block stop) or other secondary safety device installed to hold the unit in case of failure of the main hoist rope. This safety line can either be installed in the motor of the climber or it can run through the cable-climbing device itself.
- (i) In the event a false car is operated in the upper part of a high-rise hoistway without enough wire rope to travel the distance, sufficient safeguards shall be taken to prevent the false car from traveling beyond the length of the wire rope.
- (j) The cable-climbing device is attached to the false car by bolting it to the lifting angle attached to the false-car safety plank. Always use case-hardened bolts with lock nuts for attachments. Some important things to watch out for are:
 - (1) Fist grips shall be used on the wire ropes of the climber. U-bolt-type clips shall not be used .
 - (2) Adequate padding shall be placed around the entire support members; and
 - (3) All bolts shall be tightened and checked on a daily basis.
- (k) Another method of hoisting a false car is to use a drum hoist outside of the hoistway. The drum hoist is rigged with overhead sheaves at the top of the hoistway to properly guide the hoist rope from the hoisting machine to the false

car. The hoisting machine shall be equipped with a slack rope switch. There shall be an operator at the hoist, and there shall be a positive two-way communication between the hoist operator and the workers on the false car. This is required any time a hoisting machine is being used from a remote location. A proper guardrail system shall be provided at the landing where the hoist is located.

- (l) Shafter and other similar-type pieces of equipment are operated in the same manner as false cars and require periodic safety tests and inspections according to the manufacturer's specifications. Shafter also have an independent safety line (block stop) to arrest the fall of the unit in the event the hoist rope fails, and shall be installed on all jobs where shafter are used.

Section 12

MATERIAL HANDLING

12.1 Manual Handling Lifting of Material

- (a) When any heavy object is to be lifted and carried to another point, first inspect and clear the area and route over which the object is to be carried. Be sure nothing is in the way that might cause slipping or tripping.
- (b) Inspect the object to be lifted to determine how it will be grasped. Make sure it is free of sharp edges, protruding nail points, slivers or other hazards that might cause injury to the hands or body. Wear appropriate gloves to protect hands. (See Section 3.)
- (c) Do not permit material storage within 6 ft (1.8 m) of escalator wellways.

Lifting Loads

- (a) Incorrect lifting methods require unnecessary effort and often cause strain or other types of injuries. When it is necessary to lift any object which is difficult for one person to handle, ask for help.
- (b) The safest way to lift is actually the easiest way to lift (see Figure 12a):

Figure 12a



- (1) Get a secure footing.
- (2) Bend at knees to grasp the object.
- (3) Keep a natural curve in back and as nearly upright as possible.
- (4) Get a firm hold.
- (5) Lift gradually by straightening legs, keeping the back as nearly straight as possible.

The same procedure must be observed when setting loads down.

- (c) Two common injuries that occur in our industry are back sprain or strain. Low-back pain is the most common ailment. The misconception that back injuries are only caused by improper lifting lulls us into a false sense of security. Overexertion, overextending, overreaching and improper bending are some of the many causes of low-back pain. Most of the low-back ailments are normally not of a serious nature, until we choose to ignore the warning signs. When this happens, the backaches become chronic.

Figure 12b

Position for Lifting



All the load is on the back

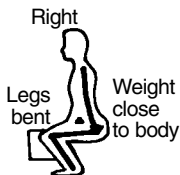


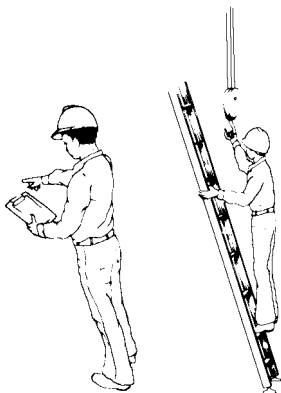
Figure 12c

HELPFUL HINTS FOR ON AND OFF THE JOB

Walk with good posture. Keep head high – chin tucked in. Don't slouch. Don't wear improper shoes.

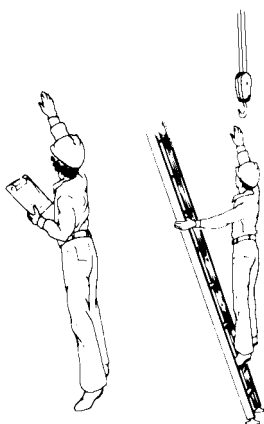


DO'S



Stay close to your work and keep feet flat on floor.

DONT'S



Don't overextend your reach by being on tip-toes.

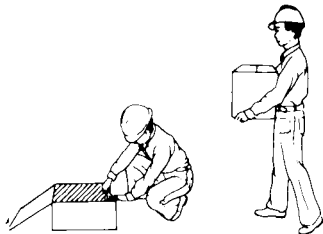
Figure 12d

DO'S



Keep feet flat on the floor when sitting. Your back should be firmly against the back of the chair.

Bend with your knees – keep a natural curve in your back. Lift objects only chest high.



Sleep on firm mattress. Sleep on your side with your knees bent.

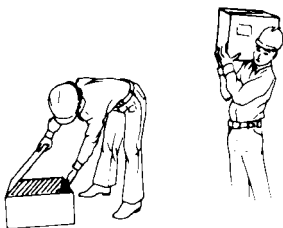


DONT'S

Don't Slump. Keep chair close to your work. Avoid excessive leaning and arching your back.



Don't bend with your legs straight. Avoid lifting above shoulder level.



Don't sleep on soft, sagging mattresses. Sleeping on your stomach will cause sway back.



12.2 Ramping and Blocking of Material

- (a) Handling of all heavy materials requires considerable care. Never use “short cuts.”
- (b) Pay particular attention to the position of fingers and feet when using rollers, pinchbars, jacks and blocking to move heavy materials and equipment.
- (c) Before trying to lift a load with a pinchbar, be sure to take an ample “bite.”
- (d) Jacks shall always be placed on a solid footing and so located that a good “bite” is provided on the object being moved.
- (e) Timber used for blocking and cribbing shall be of adequate size to carry and distribute loads being supported.
- (f) When placing blocking and cribbing, be sure to have ample bearing surface. Never stack the timber in such a manner that maneuvering the load could cause it to tip.
- (g) Whenever more than two tiers of timber are used, be sure to cross-rib.
- (h) Secure skid-boards to eliminate the possibility of their shifting, and block or crib them to prevent excessive or uneven deflection.
- (i) Passageways for the movement of materials and equipment shall be cleared of debris and obstacles to afford needed working space and ease of movement.
- (j) Before moving extremely heavy loads (machines, escalator trusses, etc.) check with your Superintendent/Manager that the floor will support the load.

12.3 Hoisting and Rigging

- (a) The cardinal rules of hoisting are: stay clear of the load at all times, never stand under the load, know the weight of the load, capacity of your equipment, the structure to which you are rigging and the overall con-

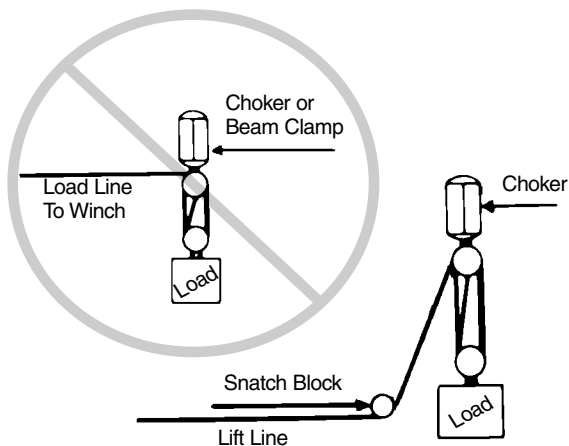
- dition of these items. Stand uphill or to the side of a load that's on a ramp.
- (b) Do not allow non-Company personnel to use Elevator Company hoisting and rigging.
 - (c) Elevator personnel must be aware of all hoisting being done in or around their work area. Always take necessary safety precautions.
 - (d) When elevator personnel are conducting hoisting operations, access to hoisting areas, especially hoistways and wellways, shall be restricted to elevator personnel involved in the lift. Warning signs shall be posted.
 - (e) Elevator personnel shall avoid areas where other trades are hoisting.
 - (f) Before making the first hoist, and at the start of each day thereafter, when the hoist is to be used, the rigging, overhead supports, blocking, etc., shall be inspected by the mechanic/MIC. The hoist shall be inspected visually prior to each use. It shall be tested by raising the load several inches and holding it there prior to making an actual lift.
 - (g) Power operated rigging equipment shall be tested to ensure the machine stalls prior to rigging breaking or coming loose (i.e., tie to major support structure – activate motor to ensure integrity of rigging system).
 - (h) The safe working load of a hoist, or any part of the rigging system, as determined by the manufacturer, shall be clearly marked on the hoist or other equipment, and this safe working load shall not be exceeded. If the hoist or other equipment is not marked with the safe working load – do not use.
 - (i) Only company approved hoisting and rigging equipment shall be used.

- (j) No alterations to any hoisting and rigging equipment shall be made without the manufacturer's written approval. Annual or manufacturer's recommended testing to certify the safe working load of the hoist shall be done by a qualified testing facility and the hoist shall be tagged or identified certifying test and date.
- (k) The supporting structure to which the hoist is attached shall have sufficient strength to support the load. (Refer to Allowable Concentrated Loads on American Standard Beams in Figure 22i).
- (l) The support shall be arranged so as to provide for free movement of the hoist and shall not restrict the hoist from lining itself up with the load.
- (m) The hoist shall be installed only in locations that permit the operator to stand clear of the load at all times.
- (n) The overhead structure shall be padded where any choke or assembly is passed over steel. This padding is essential to keeping the rigging in good condition.
- (o) Only properly made wire rope or nylon slings and chokers shall be used for rigging.
- (p) Do not use the hoist chain as a choker.
- (q) Do not use a jack wrench as a lifting block. These are not designed for these uses.
- (r) The use of two or more chain hoists for hoisting a single load is not permitted, unless any one of them will handle the entire load by itself.
- (s) Whenever a load cannot be lifted by one person pulling on the chain, investigate for overload or a defect in the chain fall.
- (t) To prevent hooks from being disengaged from the load or overhead support, it is recommended that only hooks with safety latches be used. Hooks which do not have safety latches shall be moused as a temporary measure.

- (u) A clevis-type shackle, with locking device or through bolt with jam nut, or nut with cotter pin, shall be used to hoist rails, brackets, etc.
- (v) Use only manufacturer recommended wire rope of the proper size for powered hoists. Always examine such wire rope for defects. Wire ropes found to be defective shall not be used.
- (w) Always wear gloves when handling wire rope.
- (x) When using a capstan hoist, do not stand in the coil of rope.
- (y) Do not rig the capstan hoist so as to overload it.
- (z) Deleted

Figure 12f

VERTICAL PULL ONLY



Do not pull so that bending stress is put on beam clamp.

- (aa) Do not drill additional holes in the capstan hoist's mounting brackets, as this could weaken the hoist.
- (ab) Deleted
- (ac) Deleted
- (ad) Rated load divided by the number of parts of the rope shall not exceed 20% of the nominal breaking strength of the rope (i.e., safety factor of 5).
- (ae) Wire rope used for supporting the top block hoist rig shall have, as a minimum, one more turn than the number of sheaves used in the traveling hoist rope, and shall be well padded where it goes around the support beam. Remember: Wire rope strength deteriorates 25% when it is wrapped around supports and is secured with U-bolt-type clips.
- (af) Hoist machines shall be substantially secured so that they will not shift under a load.
- (ag) When starting a lift, gradually take slack out of slings and make sure that no one's hands are in a position to be caught between the load and sling hook.
- (ah) Never attempt to make a lift or move equipment when anyone is in a position to be injured should the load shift or fall.
- (ai) Do not drag sling, chains, etc., along the floor or across equipment.
- (aj) When hoisting rails into a hoistway, and the guardrail system must be removed to allow access, if there is more than a 6 ft (1.8 m) fall exposure, the employee feeding the rails into the hoistway shall be protected from falling into the hoistway by a personal fall arrest system attached to a lifeline. Remember to keep the guardrail system up on the unused portions of the hoistway and keep others out of your hoisting area.

Figure 12e

**Allowable Number of Broken Strands
for Wire Ropes used in Hoisting Equipment**

1. Six randomly distributed broken wires in one lay.
2. Three broken wires in one strand on one lay.
3. If one-third of the outside wires show wear or disintegrate at any place on the rope.

Causes Of Wire Rope Failure

1. Using wire rope of insufficient strength for the job.
2. Improper rigging.
3. Kinking.
4. Improper lubrication, storage and care, allowing rusting, corrosion or internal abrasion.
5. Exposure to extreme heat.
6. Crushing on winch drum.
7. Using drums or sheaves of insufficient diameter of incorrect tread.
8. Permitting ropes to abrade over sharp corners or other fixed objects.
9. Contact with electrical current.

Signs Of Wire Rope Deterioration

1. Reduction of rope diameter below nominal diameter due to loss of core support, internal/external corrosion, or wear of outside wire.
2. Broken outside wires and degree of distribution or concentration of broken wires.
3. Worn outside wires.
4. Corroded, rusty or broken wires at end connections.
5. Severe kinking, crushing, cutting and/or unstranding.

- (ak) Clear communications are required. All verbal commands shall be repeated by the receiving party and reconfirmed by the directing party.

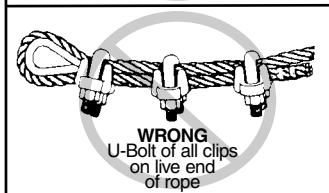
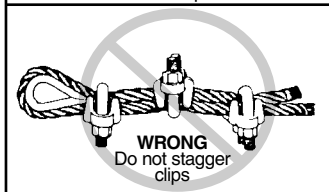
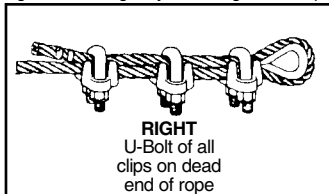
12.4 Wire Rope Fastenings

- (a) When it is necessary to make a short bend, as in attaching wire rope or when it is to be looped, thimbles shall always be used.
- (b) Fist grips are preferred fasteners because the wire rope does not become damaged
- (c) If using U-bolt-type clips, apply them with the U-bolt on the dead end of the rope (see Figure 12h). Tighten the nuts evenly on each clip. Retighten if necessary after load has been applied.
- (d) In forming an eye, the loose or “dead” end is clamped against the main part of the rope, with the wire-rope clips spaced a distance equal to six times the diameter of the rope.
- (e) Wire-rope clip fastenings seldom develop more than 80% of rope strength, at best.
- (f) The point of greatest fatigue and/or wear in a rope usually develops at or near the end where it is attached to the becket on the block. Clips shall be inspected at least daily, and tightened if they show signs of loosening. All connections shall be periodically disassembled and the wire rope inspected for damage on a regular basis.

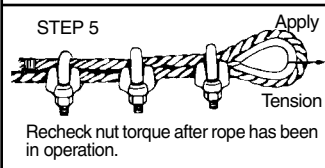
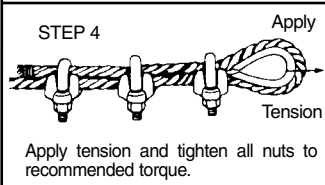
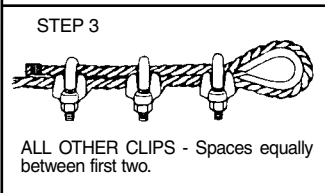
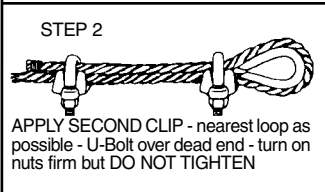
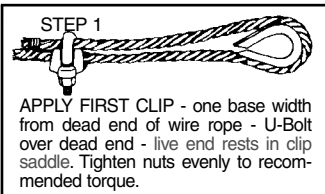
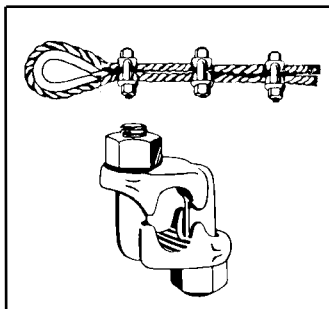
Figure 12g

Right and Wrong Ways of Using Cable Clips

Proper Methods of Installing Cable Clips



Double Saddle Clips (Fist Grip and "J" Clips)



12.5 Chain Hoists

- (a) Generally chain hoists are more durable, more adaptable and stronger than block and tackle.
- (b) All chain hoists shall be visually inspected for defects prior to first use, and daily when in use.
- (c) The lower hook on all chain hoists is designed to be the weakest part and will spread when overloaded. When this occurs, the entire hoist shall be inspected.
- (d) Damaged hoists shall be removed from service.
- (e) Repairs shall only be made by an authorized representative of the manufacturer. This includes the replacement of a chain.
- (f) The unit shall be returned to the vendor for testing, maintenance and internal inspection as recommended by the manufacturer.
- (g) Always use proper hand signals when hoisting. See Figures 12i and 12j.
- (h) Discard hooks that spread beyond allowable spread, see Figure 12y.

12.6 Slings and Hitches

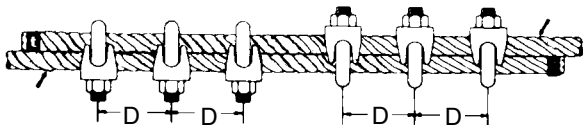
- (a) Chain slings shall not be used when hoisting material.
- (b) Nylon slings are to be used for hoisting equipment within their rated load. Label with rating shall be attached to sling.
- (c) Nylon slings shall be inspected for cuts or tears before using and damaged slings discarded.
- (d) The type of sling or hitch to be used shall be determined from the shape of the load and by the flexibility and condition of the rope. In lifting multiple objects, such as a load of lumber or steel sheathing, the sling must bind on the load sufficiently to prevent slipping of the individual pieces. In handling single pieces, such as timbers, posts

or piles, a timber hitch with two half-hitches (or a similar hitch) shall be used.

- (e) Only approved slings of proper size shall be used for slinging loads.
- (f) In using wire rope as straps for hooking onto tackle blocks, there shall be the same number of parts of rope in the strap as there are moving parts in the tackle. For instance, if triple-block tackle is used, there shall be six parts of rope for the strap.
- (g) Endless wire slings shall be made using a minimum of six u-bolt rope clips as shown in Figure 12h. If the rope is greater than 5/8 in. (16 mm) additional u-bolt rope clips are required, see Figure 12ac.

Figure 12h

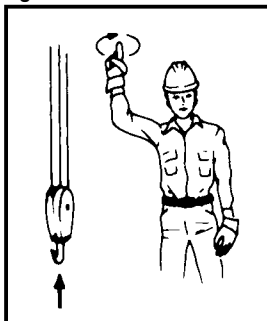
ENDLESS SLING ASSEMBLY



D = 6 times diameter of rope

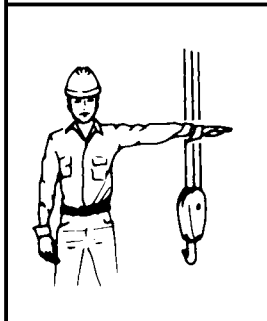
Figure 12i

HAND HOISTING SIGNALS



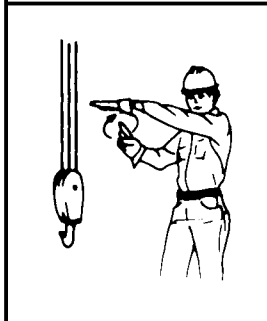
HOIST.

With forearm vertical, forefinger pointing up move hand in small horizontal circle.



STOP.

Arm extended palm down, hold position rigidly.



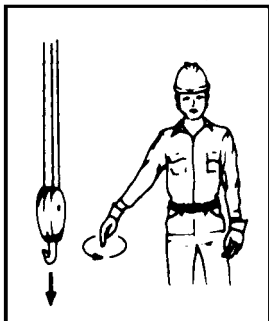
MOVE SLOWLY.

Use one hand to give any motion signal and place other hand motionless in front of hand giving the motion signal. (Hoist Slowly shown in example.)

HAND HOISTING SIGNALS

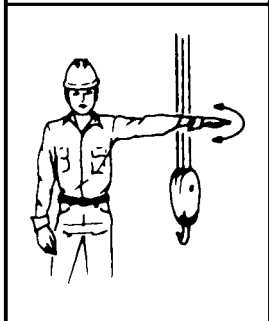
LOWER.

With arm extended downward, forefinger pointing down, move hand in small horizontal circles.



EMERGENCY STOP.

Arm extended, palm down, move hand rapidly right and left.



DOG EVERYTHING.

Clasp hands in front of body.

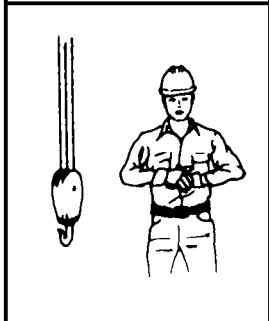
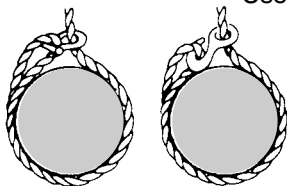


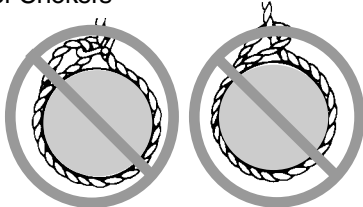
Figure 12k

RIGHT AND WRONG RIGGING PRACTICES

Use of Chokers

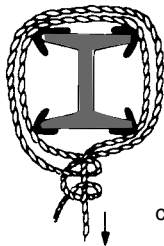


RIGHT:
No cutting action
on running lines.



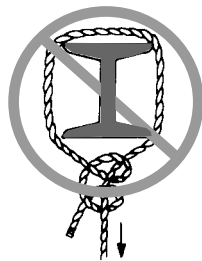
WRONG:
Right, because of cutting action of
eye splice on running lines. Left,
bolt on running line can work loose.

Suspending Needle Beams or Scaffolds



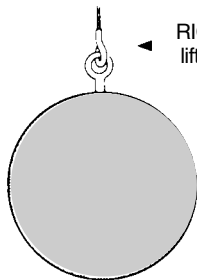
RIGHT: Sharp
corners padded.

WRONG:
Steel can
cut rope.



(Also see Section 12.7 Crosby Lifting Guide)

Eye Bolts



RIGHT: Vertical
lift on eye bolt.

WRONG:
Lifting on eye
bolts from an
angle reduces
safe loads as
much as 90%.

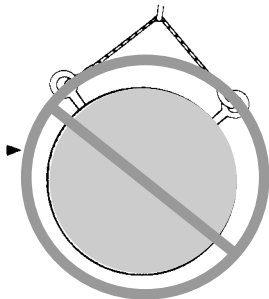
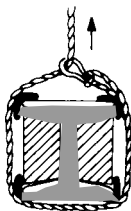


Figure 12l

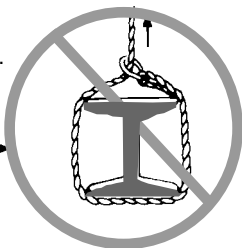
RIGHT AND WRONG RIGGING PRACTICES

Hoisting Structural Steel

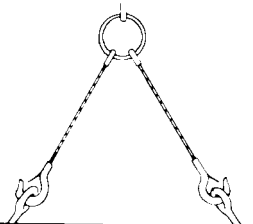


RIGHT: Use space blocks and pad corners.

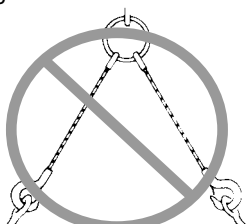
WRONG: Can bend flanges and cut rope.



Hook Slings



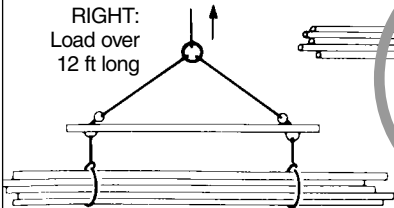
RIGHT:
Hooks are turned out.



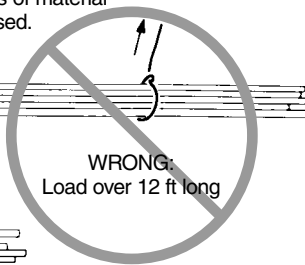
WRONG: Hook openings should be turned out.

NOTE: When hoisting 2 or more pieces of material over 12 ft long, double slings shall be used.

RIGHT:
Load over
12 ft long



WRONG:
Load over 12 ft long



(Also see Section 12.7 Crosby Lifting Guide)

(Also see Section 12.7 Crosby Lifting Guide)

12.7 Crosby Lifting Guide

The following pages of information in this section have been printed with permission of The Crosby Group Inc. The strengths of the slings, shackles and other rigging equipment identified within these pages are to be used in conjunction with the referenced Crosby products. When using rigging equipment not manufactured by Crosby, obtain appropriate strength and capacity information from the manufacturer of the products that are being used.

Figure 12m


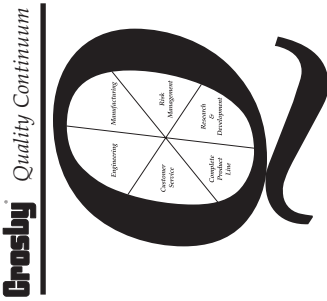
Crosby USER'S GUIDE LIFTING		1 VERSION (4/02)
RISK MANAGEMENT DEFINITION COMPREHENSIVE SET OF ACTIONS THAT REDUCES THE RISK OF A PROBLEM, A FAILURE, AN ACCIDENT	TERMINOLOGY WORKING LOAD LIMIT (WLL) THE MAXIMUM MASS OR FORCE WHICH THE PRODUCT IS AUTHORIZED TO SUPPORT IN A PARTICULAR SERVICE. PROOF TEST A TEST APPLIED TO A PRODUCT SOLELY TO DETERMINE INJURIOUS MATERIAL OR MANUFACTURING DEFECTS. ULTIMATE STRENGTH THE AVERAGE LOAD OR FORCE AT WHICH THE PRODUCT FAILS OR NO LONGER SUPPORTS THE LOAD. DESIGN FACTOR AN INDUSTRIAL TERM DENOTING A PRODUCT'S THEORETICAL RESERVE CAPABILITY; USUALLY COMPUTED BY DIVIDING THE CATALOG ULTIMATE LOAD BY THE WORKING LOAD LIMIT, GENERALLY EXPRESSED AS A RATIO, e.g. 5 TO 1.	FOR ADDITIONAL SUPPORT  <p>P.O. Box 3128 Tulsa Oklahoma 74101 Phone: (918) 834-4611 Fax: (918) 832-0940 1-800-777-1555</p> <p>Web: www.thecrosbygroup.com E-Mail: crosbygroup@thecrosbygroup.com</p> <div style="background-color: black; color: white; padding: 5px; text-align: center;"> BLOCKS & FITTINGS FOR WIRE ROPE & CHAIN </div> <p>CROSBY® FITTINGS LEBUS® McKISSICK® WESTERN NATIONAL</p>
 <p>Crosby Quality Continuum</p>		

Figure 12n




THE BASIC RIGGING PLAN	RESPONSIBILITY
<p>1. WHO IS RESPONSIBLE (COMPETENT) FOR THE RIGGING? COMMUNICATION ESTABLISHED?</p> <p>2. IS THE EQUIPMENT IN ACCEPTABLE CONDITION? APPROPRIATE TYPE, PROPER IDENTIFICATION? ARE THE WORKING LOAD LIMITS ADEQUATE? CAPACITY OF GEAR KNOWN?</p> <p>WHAT IS THE WEIGHT OF LOAD? WHERE IS THE CENTER OF GRAVITY? WHAT IS THE SLING ANGLE? WILL THERE BE ANY ANGULAR OR SIDE LOADING? ARE THE SLINGS PADDED AGAINST SHARP CORNERS?</p> <p>4. WILL THE LOAD BE UNDER CONTROL? IS THE LOAD RIGGED TO THE CENTER OF GRAVITY? IS THE HITCH APPROPRIATE? TAG LINE NEEDED? IS THERE ANY POSSIBILITY OF FOULING? CLEAR OF PERSONNEL?</p> <p>5. ARE THERE ANY UNUSUAL LOADING OR ENVIRONMENTAL CONDITIONS? WIND, TEMPERATURE, OTHER? 6. SPECIAL REQUIREMENTS?</p> <div style="text-align: right;">   </div>	<p style="text-align: center;">2</p> <p style="text-align: center;">USER RESPONSIBILITY</p> <ol style="list-style-type: none"> UTILIZE APPROPRIATE RIGGING GEAR SUITABLE FOR OVERHEAD LIFTING. UTILIZE THE RIGGING GEAR WITHIN INDUSTRY STANDARDS AND THE MANUFACTURER'S RECOMMENDATIONS. CONDUCT REGULAR INSPECTION AND MAINTENANCE OF THE RIGGING GEAR. <p style="text-align: center;">MANUFACTURERS RESPONSIBILITY</p> <ol style="list-style-type: none"> PRODUCT AND APPLICATION INFORMATION PRODUCT THAT IS CLEARLY IDENTIFIED <ul style="list-style-type: none"> NAME OR LOGO LOAD RATING AND SIZE TRACEABILITY PRODUCT PERFORMANCE <ul style="list-style-type: none"> WORKING LOAD LIMIT DUCTILITY FATIGUE PROPERTIES IMPACT PROPERTIES <div style="text-align: right;">  </div>

Figure 12o

<p>INSPECTION OF HARDWARE</p>	<p>INSPECTION OF WIRE ROPE SLINGS 3</p>
<p>DEFORMATION</p> <p>REMOVE FROM SERVICE IF ANY SIGNIFICANT DEFORMATION. CHECK THROAT OPENING OF HOOKS.</p> <p>WEAR</p> <p>REMOVE FROM SERVICE IF EXCESSIVE WEAR. WEAR IS EXCESSIVE IF:</p> <ul style="list-style-type: none"> MORE THAN 5% WEAR IN THROAT OR EYE OF HOOK AND OTHER CRITICAL AREAS OF HARDWARE. MORE THAN 10% WEAR IN OTHER AREAS. <p>CRACKS, NICKS, GOUGES</p> <p>REMOVE FROM SERVICE IF CRACKS, NICKS, OR GOUGES ARE DETECTED.</p> <p>MODIFICATION</p> <p>DO NOT WELD, DO NOT SUBSTITUTE SHACKLE PINS OR OTHER COMPONENTS, DO NOT HEAT, BEND OR MODIFY IN ANY MANNER.</p> <p>PROPER FUNCTION</p> <p>IMPROPERLY INSTALLED HARDWARE OR MALFUNCTION IS CAUSE FOR REMOVAL. CHECK FOR LATCHES, SWIVEL BEARINGS, LOCKING DEVICES, AND INSTALLATION OF WIRE ROPE CLIPS AND WEDGE SOCKETS.</p>	<p>PER ANSI B30.9</p> <p>ALL SLINGS AND ATTACHMENTS SHALL BE VISUALLY INSPECTED BY THE PERSON HANDLING THE SLING EACH DAY THEY ARE USED. IN ADDITION, A PERIODIC INSPECTION SHALL BE PERFORMED BY A DESIGNATED PERSON, AT LEAST ANNUALLY, AND SHALL INCLUDE A RECORD OF THE INSPECTION.</p> <p>INSPECTION CRITERIA</p> <ul style="list-style-type: none"> KINKING CRUSHING UNSTRANDING BROKEN OR CUT STRANDS STRANDING DISPLACEMENT <p>BROKEN WIRES</p> <p>REMOVE FROM SERVICE STRAND LAID AND SINGLE PART SLINGS IF TEN OR MORE RANDOMLY DISTRIBUTED WIRES IN ONE ROPE LAY, OR FIVE BROKEN WIRES IN ONE ROPE STRAND IN ONE ROPE LAY.</p> <p>DISTORTION OF WIRE ROPE</p> <p>REMOVE FROM SERVICE WIRE ROPE SLINGS THAT HAVE ANY DAMAGE RESULTING IN DISTORTION OF THE WIRE ROPE STRUCTURE SUCH AS KINKING, CRUSHING, UNSTRANDING, BIRDCAGING, STRAND DISPLACEMENT OR CORE PROTRUSION.</p>

Figure 12p

<p>INSPECTION OF CHAIN SLINGS</p> <p>PER ANSI B30.9</p>	<p>INSPECTION OF SYNTHETIC SLINGS⁴</p> <p>PER ANSI B30.9</p>
<p>ALL SLINGS AND ATTACHMENTS SHALL BE VISUALLY INSPECTED BY THE PERSON HANDLING THE SLING EACH DAY THEY ARE USED. IN ADDITION, A PERIODIC INSPECTION (NORMAL SERVICE: YEARLY, SEVERE SERVICE: MONTHLY) SHALL BE PERFORMED BY A DESIGNATED PERSON, AT LEAST ANNUALLY, AND SHALL INCLUDE A RECORD OF THE INSPECTION.</p> <p>INSPECTION CRITERIA</p> <p>WEAR NICK, CRACKS, BREAKS GOUGES, STRETCH, BENDS</p> <p>WELD SPLATTER EXCESSIVE TEMPERATURE THROAT OPENING OF HOOK</p> <p>CHAIN LINKS</p> <p>REMOVE SLING FROM SERVICE IF LINKS ARE WORN EXCESSIVELY (MORE THAN 10% OR REFER TO MANUFACTURER'S INFORMATION), SHARP TRANSVERSE NICKS AND GOUGES SHOULD BE ROUNDED OUT BY GRINDING (DO NOT EXCEED WEAR ALLOWANCE). CHAIN LINKS AND ATTACHMENTS SHOULD HINGE FREELY TO ADJACENT LINKS.</p> <p>IDENTIFICATION</p> <p>CHAIN SLINGS SHALL HAVE PERMANENTLY AFFIXED IDENTIFICATION STATING: SIZE, GRADE, RATED LOAD, NUMBER OF LEGS AND MANUFACTURER.</p>	<p>ALL SLINGS AND ATTACHMENTS SHALL BE VISUALLY INSPECTED BY THE PERSON HANDLING THE SLING EACH DAY THEY ARE USED. IN ADDITION, A PERIODIC INSPECTION SHALL BE PERFORMED BY A DESIGNATED PERSON, AT LEAST ANNUALLY, AND SHALL INCLUDE A RECORD OF THE INSPECTION.</p> <p>INSPECTION CRITERIA</p> <p>ACID OR CAUSTIC BURNS MELTING OR CHARRING HOLES, CUTS TEARS, SNAGS</p> <p>BROKEN STITCHES WORN STITCHES EXCESSIVE ABRASION KNOTS</p> <p>ROUND SLING NOTES</p> <p>REMOVE FROM SERVICE ROUND SLINGS THAT HAVE CORE FIBER EXPOSED BY HOLES, TEARS, CUTS, EMBEDDED PARTICLES, WEAR OR SNAGS. REMOVE FROM SERVICE ROUND SLINGS THAT HAVE MELTING, CHARRING OR WELD SPLATTER ON ANY PART OF SLING.</p> <p>IDENTIFICATION</p> <p>WEB SLINGS AND ROUND SLINGS SHALL BE PERMANENTLY MARKED INDICATING: MANUFACTURER'S TRADEMARK AND CODE (OR STOCK NUMBER), RATED LOADS FOR THE THREE HITCHES AND MATERIAL.</p>

Figure 12q

6 X 19 AND 6 X 37 IMPROVED PLOW STEEL - IWRC 5/1 DESIGN FACTOR								
WIRE ROPE SIZE	Grosby Q & T CARBON SHACKLE MINIMUM SHACKLE SIZE FOR A D/d>=1 AT LOAD CONNECTION	VERTICAL (SINGLE LEG)	ANGLE 120	CHOKER	TWO LEG OR BASKET HITCH	60 DEGREE SLING ANGLE	45 DEGREE SLING ANGLE	30 DEGREE SLING ANGLE
1/4	5/16	1120		820	2200	19-40	1500	1120
5/16	3/8	1740		1280	3400	3000	2400	1740
3/8	7/16	2400		1840	4800	4200	3400	2400
7/16	1/2	3400		2400	6800	5800	4800	3400
1/2	5/8	4400		3200	8800	7600	6200	4400
9/16	5/8	5600		4000	11200	9600	7900	5600
5/8	3/4	6800		5000	13600	11800	9600	6800
3/4	7/8	9800		7200	19600	16900	13800	9800
1	1-1/8	13200		9600	26400	22800	18600	13200
1-1/8	1-1/4	20000		12600	34000	30000	24000	17000
1-1/4	1-3/8	26000		15800	40000	34600	28300	20000
1-3/8	1-1/2	30000		19400	52000	45000	36700	26000
				24000	60000	52000	42400	30000
* RATED CAPACITIES BASED ON PIN DIAMETER OR HOOK NO LONGER THAN THE NATURAL EYE WIDTH (1/2 X EYE LENGTH) OR LESS THAN THE NOMINAL SLING DIAMETER								
REFER TO ANSI B30.9 FOR FULL DETAILS								
HORIZONTAL SLING ANGLES OF LESS THAN 30 DEGREES ARE NOT RECOMMENDED								

Figure 12r

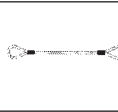


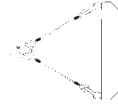
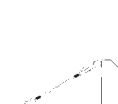

WIRE ROPE SLING CAPACITIES - TONS (2000 LBS.) - FLEMISH EYE - ASME B30.9 5A						
6 X 19 AND 6 X 37 EXTRA IMPROVED PLOW STEEL - IWRC 5/1 DESIGN FACTOR						
HORIZONTAL SLING ANGLES OF LESS THAN 30 DEGREES ARE NOT RECOMMENDED						
WIRE ROPE SIZE INCHES						
	SINGLE LEG (VERTICAL)	SINGLE CHOKER	TWO LEG SLING VERTICAL	TWO LEG SLING 60° HORIZONTAL SLING ANGLE		TWO LEG CHOKER 60° HORIZONTAL SLING ANGLE
				1.1	0.9	0.8
1/4	0.65	0.48	1.3			
3/8	1.4	1.1	2.9	2.5	2.0	1.8
7/16	1.9	1.4	3.9	3.4	2.7	2.5
1/2	2.5	1.9	5.1	4.4	3.6	3.2
9/16	3.2	2.4	6.4	5.5	4.5	4.1
5/8	3.9	2.9	7.8	6.8	5.5	5.0
3/4	5.6	4.1	11.0	9.7	7.9	7.1
7/8	7.6	5.6	15.0	13.0	11.0	9.7
1	9.8	7.2	20.0	17.0	14.0	13.0
1-1/8	12.0	9.1	24.0	21.0	17.0	16.0
1-1/4	15.0	11.0	30.0	26.0	21.0	19.0

Figure 12s

WIRE ROPE SLINGS AND CONNECTIONS TO FITTINGS

USE A THIMBLE TO PROTECT SLING AND INCREASE D/d

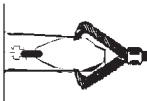


NEVER PLACE EYE OVER A FITTING SMALLER DIAMETER OR WIDTH THAN THE ROPE'S DIAMETER.



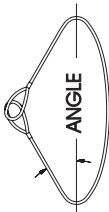
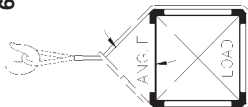
WIRE ROPE SLINGS AND CONNECTIONS TO FITTINGS

NEVER PLACE A SLING EYE OVER A FITTING WITH A DIAMETER OR WIDTH GREATER THAN ONE HALF THE NATURAL LENGTH OF THE EYE.



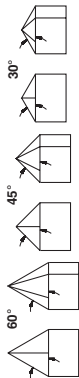
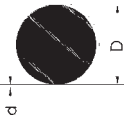
A CHOKER HITCH HAS 75% OF THE CAPACITY OF A SINGLE LEG ONLY IF THE CORNERS ARE SOFTENED AND THE HORIZONTAL ANGLE IS GREATER THAN 30 DEGREES. USE A BLOCK OF WOOD UNDER CHOKE TO INSURE ANGLE IS PROPER.

6



ANGLE	CAPACITY % OF SINGLE LEG
90	200 %
60	170 %
45	140 %
30	100 %

A BASKET HITCH HAS TWICE THE CAPACITY OF A SINGLE LEG ONLY IF D/d RATIO IS 25/1 AND THE LEGS ARE VERTICAL.




TRIPLE LEG SLINGS HAVE 50% MORE CAPACITY THAN DOUBLE LEG ONLY IF THE CENTER OF GRAVITY IS IN CENTER OF CONNECTION POINT AND LEGS ARE ADJUSTED PROPERLY (EQUAL SHARE OF THE LOAD)
 QUAD LEG SLINGS OFFER IMPROVED STABILITY BUT DO NOT PROVIDE INCREASED LIFTING CAPACITY.

Figure 12t

CHAIN SLING CAPACITIES (LBS.) - CHAIN GR-8 - ASME B30.9 DESIGN FACTOR 4/1						7	
CHAIN SIZE (IN.)	VERTICAL (SINGLE LEG)	TWO LEG OR BASKET HITCH	60 DEGREE SLING ANGLE	45 DEGREE SLING ANGLE	30 DEGREE SLING ANGLE	Grosby [®] QT ALLOY	
						SINGLE LEG MASTER LINK SIZE (IN.)	DOUBLE LEG MASTER LINK SIZE (IN.)
1/4 - (9/32)	3500	7000	6050	4900	3500	1/2	1/2
3/8	7100	14200	12200	10000	7100	3/4	3/4
1/2	12000	24000	20750	16950	12000	7/8	1
5/8	18100	36200	31350	25500	18100	1	1-1/4
3/4	28300	56600	49000	40000	28300	1-1/4	1-1/2
7/8	34200	68400	59200	48350	34200	1-1/2	1-3/4
1	47700	95400	82600	67450	47700	—	—
1-1/4	72300	144600	125200	102200	72300	—	—

HORIZONTAL ANGLE	CAPACITY % OF SINGLE LEG
90	200%
60	170%
45	140%
30	100%

A CHAIN GRAB HOOK APPLICATION WILL RESULT IN A 20% REDUCTION OF CHAIN CAPACITY OF A SINGLE LEG. THE HORIZONTAL ANGLE MUST BE GREATER THAN 30 DEGREES.



TRIPLE LEG SLINGS HAVE 50% MORE CAPACITY THAN DOUBLE LEG ONLY IF THE CENTER OF GRAVITY IS IN CENTER OF CONNECTION POINT AND LEGS ARE ADJUSTED PROPERLY (EQUAL SHARE OF THE LOAD). QUAD LEG SLINGS OFFER IMPROVED STABILITY BUT DO NOT PROVIDE INCREASED LIFTING CAPACITY.

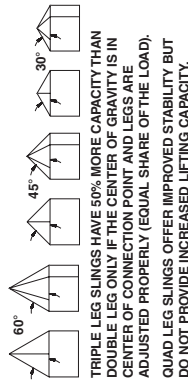
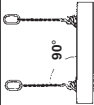
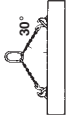


Figure 12u

CHAIN SLING CAPACITIES (LBS.) - CHAIN GR-10 - ASME B30.9 DESIGN FACTOR 4/1		7A	
		Crosby® QT ALLOY	
CHAIN SIZE (IN.)			
CHAIN GR - 10 4 TO 1 DESIGN FACTOR	VERTICAL (SINGLE LEG)	TWO LEG OR BASKET HITCH	30 DEGREE SLING ANGLE
1/4 - (9/32)	4300	8600	4300
5/16	5700	11400	5700
3/8	8800	17600	8800
1/2	15000	30000	15000
5/8	22600	45200	22600
			DOUBLE LEG MASTER LINK SIZE (IN.)
			1/4-5/16 in.
			1/4-5/16 in.
			3/8 in.
			1/2 in.
			5/8 in.
			3/4 in.

Crosby® Spectrum® 10 System Makes Assembly Easy



A-1342 Master Link

Figure 12v

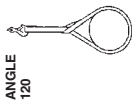
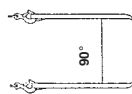
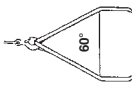
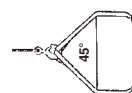
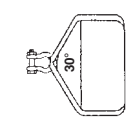
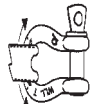

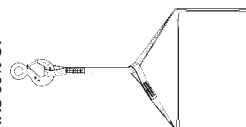



WEB SLING CAPACITIES - ANSI B30.9 - DESIGN FACTOR 5/1					9	
	ANGLE 120		90°			
VERTICAL (SINGLE LEG)	100% OF SINGLE LEG	CHOKER 80% OF SINGLE LEG	TWO LEG OR BASKET 200% OF SINGLE LEG	60 DEGREE SLING ANGLE 170% OF SINGLE LEG	45 DEGREE SLING ANGLE 140% OF SINGLE LEG	30 DEGREE SLING ANGLE SAME AS SINGLE LEG
<p>SYNTHETIC SLINGS RATED LOAD</p> <p>FOLDING, BUNCHING OR PINCHING OF SYNTHETIC SLINGS, WHICH OCCURS WHEN USED WITH SHACKLES, HOOKS OR OTHER APPLICATION WILL REDUCE THE RATED LOAD.</p>  <p>BUNCHING</p>  <p>PINCHING</p>		<p>A CHOKER HITCH HAS 80% OF THE CAPACITY OF A SINGLE LEG IF THE CORNERS ARE SOFTENED AND THE HORIZONTAL ANGLE IS GREATER THAN 30 DEGREES. USE A BLOCK OF WOOD UNDER CHOKE TO INSURE ANGLE IS PROPER.</p>  <p>TRIPLE LEG SLINGS HAVE 50% MORE CAPACITY THAN DOUBLE LEG ONLY IF THE CENTER OF GRAVITY IS IN CENTER OF CONNECTION POINT AND LEGS ARE ADJUSTED PROPERLY (EQUAL SHARE OF THE LOAD).</p>  <p>60°</p>  <p>45°</p>  <p>30°</p> <p>QUAD LEG SLINGS OFFER IMPROVED STABILITY BUT DO NOT PROVIDE INCREASED LIFTING CAPACITY.</p>				

Figure 12w

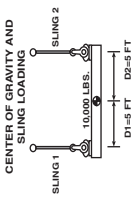
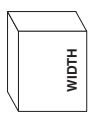
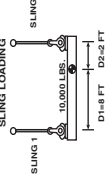
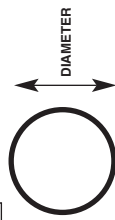
10	
<p>CENTER OF GRAVITY AND SLING LOADING</p> <p>WHEN LIFTING VERTICALLY, THE LOAD WILL BE SHARED EQUALLY IF THE CENTER OF GRAVITY IS PLACED EQUALLY BETWEEN THE PICK POINTS. IF THE WEIGHT OF THE LOAD IS 10,000 LBS., THEN EACH SLING WILL HAVE A LOAD OF 5,000 LBS. AND EACH SHACKLE AND EYEBOLT WILL ALSO HAVE A LOAD OF 5,000 LBS.</p> 	<p>WEIGHT = VOLUME X UNIT WEIGHT OF MATERIAL</p> <p>UNIT WEIGHT STEEL = 490 LBS/FT³ UNIT WEIGHT ALUMINUM = 165 LBS/FT³ UNIT WEIGHT CONCRETE = 150 LBS/FT³ UNIT WEIGHT WOOD = 50 LBS/FT³ UNIT WEIGHT WATER = 62 LBS/FT³ UNIT WEIGHT SAND AND GRAVEL = 120 LBS/FT³</p> <p>VOLUME OF CUBE = HEIGHT x WIDTH x LENGTH</p> 
<p>CENTER OF GRAVITY AND SLING LOADING</p> <p>WHEN THE CENTER OF GRAVITY IS NOT EQUALLY SPACED BETWEEN THE PICK POINTS, THE SLING AND FITTINGS WILL NOT CARRY AN EQUAL SHARE OF THE LOAD. THE SLING CONNECTED TO THE PICK POINT CLOSEST TO THE CENTER OF GRAVITY WILL CARRY THE GREATEST SHARE OF THE LOAD. SLING 2 IS CLOSEST TO COG. IT WILL HAVE THE GREATEST SHARE OF THE LOAD.</p> <p>SLING 2 = 10,000 X 8 / (8+2) = 8,000 LBS. SLING 1 = 10,000 X 2 / (8+2) = 2,000 LBS.</p> 	<p>WEIGHT = VOLUME X UNIT WEIGHT OF MATERIAL</p> <p>VOLUME OF SPHERE = $3.14 \times (\text{DIAM.} \times \text{DIAM.} \times \text{DIAM.}) / 6$</p> <p>VOLUME OF CYLINDER = $3.14 \times (\text{DIAM.} \times \text{DIAM.} \times \text{LENGTH}) / 4$</p> 

Figure 12x

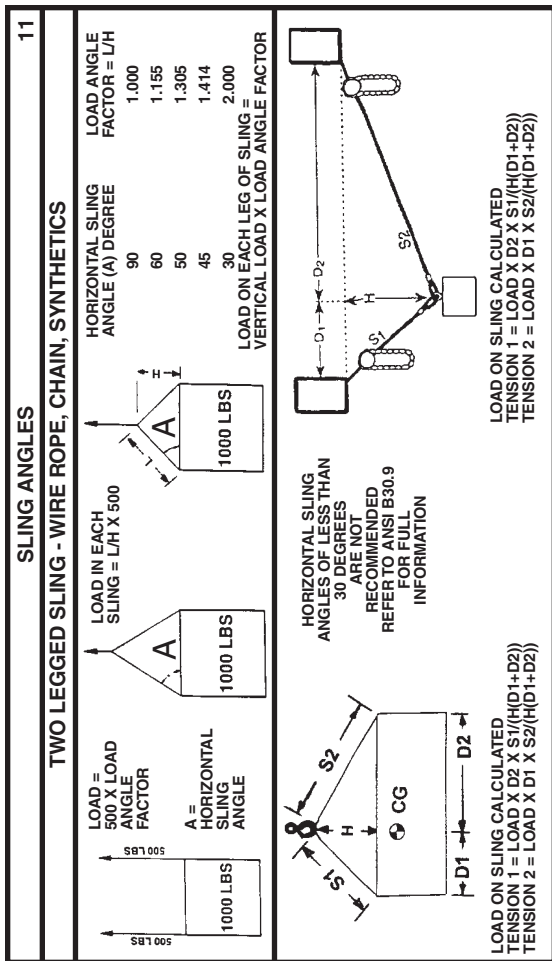


Figure 12y

Crosby [®] SHACKLES QUENCHED & TEMPERED IN METRIC TONS		Crosby [®] RIGGING HARDWARE QUENCHED & TEMPERED IN METRIC TONS		Crosby [®] HOOKS QUENCHED & TEMPERED IN METRIC TONS		DESIGN FACTOR QUICK-CHECK [®]			
NOMINAL DIAMETER OF BOW	CARBON MAXIMUM WORKING LOAD TONS	ALLOY MAXIMUM WORKING LOAD TONS	INSIDE WIDTH AT PIN (INCHES)	DIAMETER OF PIN	CARBON MAXIMUM WORKING LOAD TONS	ALLOY MAXIMUM WORKING LOAD TONS	CODE	THROAT OPENING (INCHES)	DEFORMATION INDICATOR A - A
3/16	1/3	1/3	.38	.25	3/4	1	DC	.89	1.50
5/16	3/4	3/4	.47	.31	1	1-1/2	FC	.91	2.00
3/8	1	1	.53	.38	1-1/2	2	GC	1.00	2.00
7/16	1-1/2	2	.66	.44	2	3	HA	1.09	2.00
1/2	2	2.6	.75	.50	3	4-1/2	IC	1.36	2.50
5/8	3-1/4	5	.81	.63	5	7	JC	1.61	3.00
3/4	4-3/4	7	1.06	.75	7-1/2	11	KC	2.08	4.00
7/8	6-1/2	9.5	1.25	.88	10	15	LC	2.27	4.00
1	8-1/2	12.5	1.69	1.13	15	22	NC	3.02	5.00
1-1/8	9-1/2	15	1.81	1.25	20	30	OC	3.25	7.00
1-1/4	12	18	2.03	1.38	25	37	PC	3.00	7.00
1-3/8	13-1/2	21	2.25	1.50	30	45	SC	3.38	8.00
1-1/2	17	30	2.38	1.63	40	60	TC	4.12	10.00

SHANK HOOK	SWIVEL HOOK	EYE HOOK
• EYEHOOKS -5/1 (EXCEPT ALLOY 30 TON AND LARGER ARE 4-1/2 TO 1)	• SHANK AND SWIVELS ARE 4-1/2 TO 1.	

SHANK HOOK	SWIVEL HOOK	EYE HOOK
• DO NOT SIDELOAD	• DO NOT TIP LOAD	• DO NOT BACKLOAD

INSURE SCREW PIN IS TIGHT BEFORE EACH LIFT

EYE HOOK

* 320 EYE HOOK IS NOW RATED AT 5 TONS

FOR ADDITIONAL INFORMATION REFER TO THE **Crosby**[®] PRODUCT WARNINGS

Figure 12z



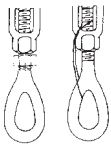
Crosby® LINKS AND RINGS WITH WIRE ROPE AND SYNTHETIC SLINGS 5/1 DESIGN FACTOR		Crosby® TURNBUCKLES	
			
WORKING LOAD LIMIT POUNDS			
SIZE INCHES	G-341	A-341	A-342
1/2	2900	7000	7000
5/8	4200	9000	9000
3/4	6000	12300	12300
7/8	8300	14000	14000
1	10800	24360	24360
1-1/8	N/A	30600	N/A
1-1/4	16750	36000	36000
1-3/8	20500	43000	N/A
1-1/2	N/A	54300	54300
1-5/8	N/A	62600	N/A
1-3/4	N/A	84900	84900
2	N/A	102600	102600
<p>WORKING LOAD LIMITS ARE FOR USE WITH WIRE ROPE AND SYNTHETIC SLINGS, NOT FOR CHAIN SLINGS. WORKING LOAD LIMITS ARE BASED ON SINGLE LEG (IN-LINE), OR RESULTANT LOAD ON MULTIPLE LEGS WITH AN INCLUDED ANGLE LESS THAN OR EQUAL TO 120 DEGREES.</p>			
		<p>WORKING LOAD LIMIT JAW AND EYE 5/1 DESIGN FACTOR</p>	
		<p>WORKING LOAD LIMIT HOOK END FITTING 5/1 DESIGN FACTOR</p>	
SIZE	500	800	400
1/4	800	1200	700
5/16	1200	2200	1000
3/8	2200	3500	1500
1/2	3500	5200	2250
5/8	5200	7200	3000
3/4	7200	10000	4000
7/8	10000	15200	5000
1	15200	21400	6500
1-1/4	21400		7500
1-1/2			
<p>THE USE OF LOCKNUTS OR MOUSING IS AN EFFECTIVE METHOD OF PREVENTING TURNBUCKLES FROM ROTATING.</p> 			
FOR ADDITIONAL INFORMATION REFER TO THE Crosby® PRODUCT WARNING			

Figure 12aa




Grosby® RIGGING HARDWARE					14
Grosby® SHOULDER EYE BOLTS		QUENCHED & TEMPERED DESIGN FACTOR 5/1	 QUIT-CHECK®	Grosby® SWIVEL HOIST RINGS	DESIGN FACTOR 5/1
SHANK DIAMETER	WORKING LOAD LIMIT IN LINEPULL (LBS.)	WORKING LOAD LIMIT 60 DEGREES SLING ANGLE (LBS.)	WORKING LOAD LIMIT 45 DEGREES SLING ANGLE (LBS.)	WORKING LOAD LIMIT FULL 180 DEGREE PIVOT (LBS.)	DESIGN FACTOR 5/1
1/4	650	420	195	800	
5/16	1200	780	360	1000	7
3/8	1550	1000	465	2500	12
1/2	2600	1690	780	4000	28
5/8	5200	3380	1560	7000	60
3/4	7200	4680	2160	8000	100
7/8	10600	6890	3180	10000	160
1	13300	8645	3990	15000	230
1-1/4	21000	13600	6300	24000	470
1-1/2	24000	15600	7200	30000	800
SHOULDER EYE BOLTS					SWIVEL HOIST RINGS
<ul style="list-style-type: none"> • NEVER EXCEED WORKING LOAD LIMITS. • NEVER USE REGULAR NUT EYE BOLTS FOR ANGULAR LIFTS. • ALWAYS USE SHOULDER NUT EYE BOLTS FOR ANGULAR LIFTS. • FOR ANGULAR LIFTS, ADJUST WORKING LOAD AS SHOWN ABOVE. • ALWAYS TIGHTEN NUTS SECURELY AGAINST THE LOAD. • ALWAYS APPLY LOAD TO EYE BOLT IN THE PLANE OF THE EYE. 					
<ul style="list-style-type: none"> • WHEN USING LIFTING SLINGS OF TWO OR MORE LEGS MAKE SURE THE FORCES IN THE LEG ARE CALCULATED. SELECT THE PROPER SIZE SWIVEL HOIST RING TO ALLOW FOR LOAD IN SLING LEG. • ALWAYS INSURE HOIST RING IS PROPERLY TORQUED TO REQUIRED VALUE. 					
Grosby® PRODUCT WARNING					

Figure 12ab

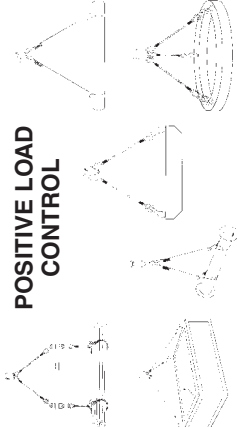
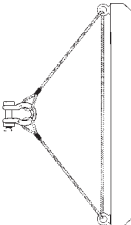



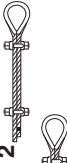

<p>OPERATING PRACTICES - ANSI B30.9</p> <p>WHENEVER ANY SLING IS USED, THE FOLLOWING PRACTICES SHALL BE OBSERVED.</p> <ol style="list-style-type: none"> 1. SLINGS THAT ARE DAMAGED OR DEFECTIVE SHALL NOT BE USED. 2. SLINGS SHALL NOT BE SHORTENED WITH KNOTS OR BOLTS OR OTHER MAKESHIFT DEVICES. 3. SLING LEGS SHALL NOT BE KINKED. 4. SLINGS SHALL NOT BE LOADED IN EXCESS OF THEIR RATED CAPACITIES. 5. SLINGS USED IN A BASKET HITCH SHALL HAVE THE LOADS BALANCED TO PREVENT SLIPPAGE. 6. SLINGS SHALL BE SECURELY ATTACHED TO THEIR LOAD. 7. SLINGS SHALL BE PADDED OR PROTECTED FROM THE SHARP EDGES OF THEIR LOADS. 8. SUSPENDED LOADS SHALL BE KEPT CLEAR OF ALL OBSTRUCTION. 9. ALL EMPLOYEES SHALL BE KEPT CLEAR OF LOADS ABOUT TO BE LIFTED AND OF SUSPENDED LOADS. 10. HANDS OR FINGERS SHALL NOT BE PLACED BETWEEN THE SLING AND ITS LOAD WHILE THE SLING IS BEING TIGHTENED AROUND THE LOAD. 11. SHOCK LOADING IS PROHIBITED! 12. A SLING SHALL NOT BE PULLED FROM UNDER A LOAD WHEN THE LOAD IS RESTING ON THE SLING. <p>INSPECTION: EACH DAY BEFORE BEING USED, THE SLING AND ALL FASTENINGS AND ATTACHMENTS SHALL BE INSPECTED FOR DAMAGE OR DEFECTS BY A COMPETENT PERSON DESIGNATED BY THE EMPLOYER. ADDITIONAL INSPECTIONS SHALL BE PERFORMED DURING SLING USE WHERE SERVICE CONDITIONS WARRANT. DAMAGED OR DEFECTIVE SLINGS SHALL BE IMMEDIATELY REMOVED FROM SERVICE.</p>	<p>LOAD CONTROL 15</p> <p>POSITIVE LOAD CONTROL</p> 	 <p>REEVING THROUGH CONNECTIONS TO LOAD INCREASES LOAD ON CONNECTION FITTINGS BY AS MUCH AS TWICE.</p> <p>DO NOT REEVE!</p>
--	---	---

Figure 12ac

Grosby RIGGING HARDWARE							
Grosby WIRE ROPE CLIPS		 G-450 U-Bolt Clip	CLIPS 80% EFFICIENT UNDER 1", 90% 1" AND ABOVE	 G-429 Fist Grip Clip	CLIPS 80% EFFICIENT UNDER 1", 90% 1" AND ABOVE		
SIZE	NUMBER OF CLIPS	TURNBACK LENGTH (IN.)	TORQUE FT.-LBS.	SIZE	NUMBER OF CLIPS	TURNBACK LENGTH (IN.)	TORQUE FT.-LBS.
1/8	2	3-1/4	4.5	3/16	2	4	30
3/16	2	3-3/4	7.5	1/4	2	4	30
1/4	2	4-3/4	15	5/16	2	5	30
5/16	2	5-1/4	30	3/8	2	5-1/4	45
3/8	2	6-1/2	45	7/16	2	6-1/2	65
7/16	2	7	65	1/2	3	11	65
1/2	3	11-1/2	65	9/16	3	12-3/4	130
9/16	3	12	95	5/8	3	13-1/2	130
5/8	3	12	95	3/4	4	16	225
3/4	4	18	130	1	5	37	225
1	5	26	225				
<p>APPLY U-BOLT OVER DEAD END OF THE WIRE ROPE. LIVE END OF THE ROPE RESTS IN THE SADDLE. A TERMINATION IS NOT COMPLETE UNTIL IT HAS BEEN RETORQUED A SECOND TIME. NEVER SADDLE A DEAD HORSE!</p> <p style="text-align: center;">  1  2  3 </p>							
<p>THE NUMBER OF CLIPS SHOWN IS BASED ON USING RRL OR RLL WIRE ROPE, 6X19 OR 6X37 CLASS, FC OR IWRC: IPS OR XIP. IT ALSO APPLIES TO ROTATION RESISTANT RRL WIRE ROPE, 8X19 CLASS, IPS, XIP. SIZES 1-1/2 INCH AND SMALLER, AND TO ROTATION RESISTANT RRL WIRE ROPE, 19X7 CLASS, IPS, XIP, SIZES 1-3/4 INCH AND SMALLER. FOR ELEVATOR, PERSONNEL HOIST, AND SMALLER, FOR ELEVATOR, PERSONNEL HOIST, AND SCAFFOLD APPLICATIONS REFER TO ANSI A17.1 AND ANSI A10.4. THESE STANDARDS DO NOT RECOMMEND THE USE OF U-BOLT STYLE WIRE ROPE CLIPS.</p>							
FOR ADDITIONAL INFORMATION REFER TO THE Grosby PRODUCT WARNING							

12.8 Synthetic Webbing Slings – Selection, Use and Maintenance

This section applies to slings fabricated by sewing of woven synthetic webbing of nylon or polyester type yarns, for the purpose of hoisting, lifting, and general material handling.

12.8.1 Construction

12.8.1.1 Webbing

Webbing should be of fabric woven of high tenacity synthetic yarns, offering suitable characteristics for use in the fabrication of web slings. Webbing shall have the following characteristics.

- (a) Sufficient certified tensile strength to meet the sling manufacturer's requirements.
- (b) Uniform thickness and width.
- (c) Full woven width, including selvage edges.
- (d) Webbing ends shall be sealed by heat, or other suitable means, to prevent raveling.

12.8.1.2 Thread

The thread used in the manufacture of synthetic web slings shall be of the same generic type yarn as the sling webbing.

12.8.1.3 Stitching

- (a) Stitching shall be the only method used to fabricate synthetic web slings within the scope of this standard.
- (b) The stitching pattern and length of stitching shall be in accordance with the manufacturer's standard practice.

12.8.1.4 Fittings

- (a) The material selected shall be compatible with the mechanical and environmental requirements imposed on the fitting. Material selected should be carbon steel, alloy steel, aluminum, or other suitable material.
- (b) Fitting shall have sufficient strength to sustain twice the rated load of the sling without permanent deformation and a minimum breaking strength equal to five times the rated load of the sling.
- (c) All surfaces shall be cleanly finished and sharp edges removed so as not to cause damage to the webbing.
- (d) Slings incorporating aluminum fittings shall not be used where fumes, vapors, sprays, mists or liquids of caustic, or acids are present.
- (e) The eye opening in the fitting shall be the proper shape and size to insure that the fitting will seat properly in the hook or other attachment.

12.8.1.5 Marking (Sling identification)

Each sling shall be permanently marked to show.

- (a) Name of trademark or manufacturer.
- (b) Manufacturer's code or stock number.
- (c) Rated loads for types of hitches used.
- (d) Type of synthetic web material.

12.8.2 Design Factor

The design factor for synthetic web slings shall be a minimum of 5.

12.8.3. Rated Load

- (a) A sling shall not be used at a load greater than that shown on its tags. Slings shall be used in accordance with the manufacturer's recommendations.
- (b) Each manufacturer shall make available on request test data to justify these recommended rated loads.

12.8.4 Proof Test

When specified by the purchaser, web slings of all types shall be proof loaded:

- (a) The proof load for single leg slings and endless slings shall be two times the vertical rated load.
- (b) The proof load for multiple leg bridle slings shall be applied to the individual legs and shall be two times the vertical rated load of a single leg sling.

12.8.5 Effects of Environment

- (a) Chemically active environments, such as acids and caustics, can affect the strength of slings the manufacturer should be consulted before slings are used in chemically active environments.
- (b) Nylon and polyester slings shall not be used at temperatures in excess of 194°F 90°C).

12.8.6 Inspection

- (a) Initial Inspection. Before using any new or repaired sling, it shall be inspected to insure that the correct sling is being used as well as to determine that the sling meets the requirements of this standard.
- (b) Frequent Inspection. This inspection should be made by the person handling the sling each day the sling is used.

- (c) Periodic Inspection. This inspection should be conducted by the Competent Person. Frequency of inspection should be based on:
 - (1) Frequency of sling use;
 - (2) Severity of service conditions; and
 - (3) Experience gained on the service life of slings used in similar applications
- (d) Periodic inspections should be conducted at least annually.

12.8.7 Removal Criteria

A sling shall be removed from service if damage such as the following is visible and shall only be returned to service when approved by a Qualified Person.

- (a) Acid or caustic burns
- (b) Melting or charring of any part of the sling
- (c) Holes, tears, cuts or snags
- (d) Broken or worn stitching in load bearing splices
- (e) Excessive abrasive wear
- (f) Knots in any part of the sling
- (g) Excessive pitting or corrosion, or cracked, distorted, or broken fittings
- (h) Other visible damage that causes doubt as to the strength of the sling.

12.8.8 Repairs

- (a) Slings shall be repaired only by a sling manufacturer or a Qualified Person. When repaired, a sling shall be permanently marked to identify the repair agent.
- (b) Temporary repairs of either webbing, fittings, or stitching shall be not permitted.
- (c) Repaired sling shall be proof tested to two times its assigned rated load before being put back into service.

12.8.9 Operating Practices

- (a) The weight of load shall be within the rated load of the sling.
- (b) Slings shall not be shortened or lengthened by knotting or other methods not approved by the sling manufacturer.
- (c) Slings that appear to be damaged shall not be used unless inspected and accepted as usable under Section 12.7.6.
- (d) Sling shall be hitched in a manner providing control of the load.
- (e) Sharp corners in contact with the sling should be padded with material of sufficient strength to minimize damage to the sling.
- (f) Personnel should stand clear of the suspended load.
- (g) Personnel shall not ride the sling.
- (h) Shock loading should be avoided.
- (i) Slings should not be pulled from under a load when the load is resting on the sling.
- (j) Slings should be stored in a cool dry, and dark place to prevent environmental damage.
- (k) Twisting and kinking the legs shall be avoided.
- (l) Load applied to the hook should be centered in the base (bowl) of hook to prevent point loading on the hook.
- (m) During lifting, with or without load, personnel shall be alert for possible snagging.
- (n) In a basket hitch, the load should be balanced to prevent slippage.
- (o) The sling's legs should contain or support the load from the sides above center of gravity when using a basket hitch.
- (p) Slings should be long enough so that the rated load is adequate when the angle of the legs is taken into consideration.
- (q) Slings should not be dragged on the floor or over an abrasive surface.
- (r) In a choker hitch, slings shall be long enough so the choker

- fitting chokes on the webbing and never on the other fitting.
- (s) Nylon and polyester slings shall not be used at temperatures in excess of 194°(F) 90°(C).
 - (t) When extensive exposure to sunlight or ultraviolet light is experienced by nylon or polyester web slings, the sling manufacturer should be consulted for recommended inspection procedure because of loss in strength.

12.9 Beam Clamps

- (a) A beam clamp used for rigging shall be engineered to properly support the expected load.
- (b) Before moving extremely heavy loads, check with your Superintendent/Manager who shall obtain the maximum load the beam will support.
- (c) Do not use a choker through the eye of the beam clamp while hoisting.
- (d) Do not load the lower flange to more than 50% of the beam's capacity.
- (e) Beam clamps shall be properly sized for the beam to which it is attached.
- (f) Use only case-hardened bolts with lock nuts or nuts with lock washers for the beam clamp assembly.

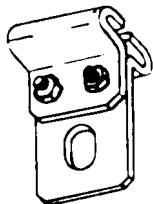


Figure 12ad

Figure 12ae

Five-Part Falls

A five-part reeve is accomplished using a two- and three-sheave block as follows: Enter the lead line through the front of the stationary block at sheave (B), then go down in back of traveling block and through at sheave (E), up behind stationary block and through at sheave (C), down in front of traveling block and through at sheave (D), up in front of stationary block and through at sheave (A), down to the traveling block and becket off. This reeving is more widely used for rope falls (manila), but is also used for wire rope (cable).

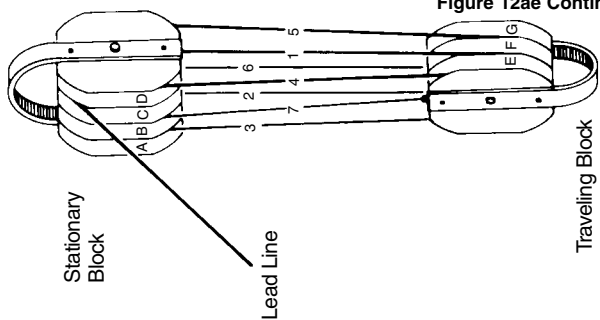
Six-Part Falls

Using a pair of three-sheave blocks, a six-part reeve is accomplished as follows: Enter the lead line through the front of the stationary block at sheave (B), then go down in front of traveling block and through at sheave (E), up behind stationary block and through at sheave (A), down behind traveling block and through at sheave (D), up in front of stationary block and through at sheave (C), down in front of traveling block and through at sheave (F), up to stationary block and becket off. This reeving is more widely used for rope falls (manila), but is also used for wire rope (cable).

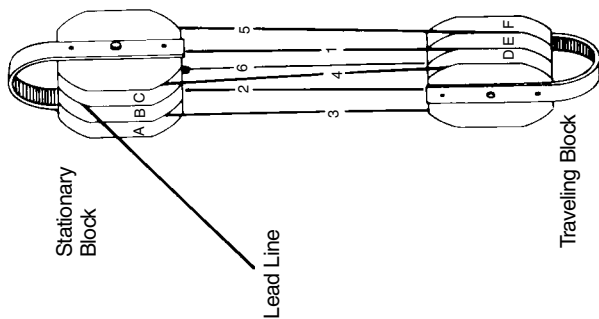
Seven-Part Falls

A seven-part reeve is accomplished using a three- and four-sheave block as follows: Enter the lead line through the front of the stationary block (four-sheave) at sheave (C), go down in front of traveling block and through at sheave (F), up behind the stationary block and through at sheave (A), down behind traveling block and through at sheave (E), up in front of stationary block and through at sheave (D), down in front of stationary block and through at sheave (G), up behind stationary block and through at sheave (B), down to the traveling block and becket off.

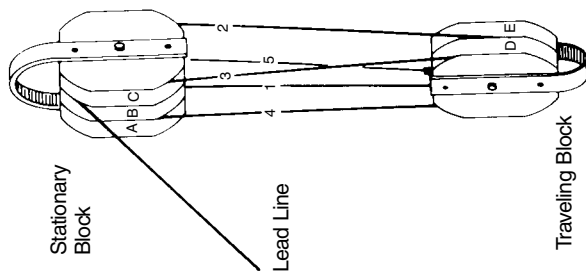
SEVEN-PART FALLS



SIX-PART FALLS



FIVE-PART FALLS



This theory applies to two-part, three-part and four-part falls.

12.10 Manila Rope

- (a) Frozen manila rope shall not be used in load-carrying service.
- (b) Manila rope shall be protected from abrasion by padding where it is fastened or drawn over square corners, or sharp or rough surfaces.
- (c) Even the finest-quality rope deteriorates very rapidly when not given the best of care. Kinking, overheating, moisture and acid all cause deterioration, which is not readily noticeable upon casual inspection.
- (d) Manila rope shall be stored in a clean, dry location. Keep off pit floor, coil into protective device such as a drum.
- (e) Manila rope is not a substitute for wire rope. It shall only be used for lashings, tackles, tag lines, straps on light leads and temporary guy lines and light hoisting.
- (f) Points to look for during manila rope inspection are:

Good Characteristics

Hard but pliant
Silvery or pearly luster
Inner fibers bright & clean
Individual yarn strong
Uncut and unabraded
outer & inner fibers
Stretch and spring good

Poor Characteristics

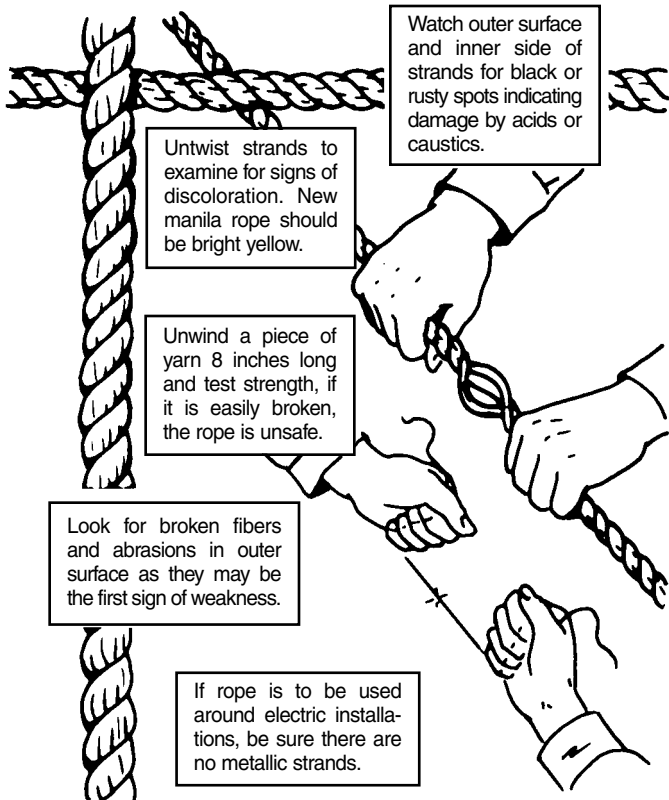
Brown spots – weak, soft
Black or dark spots – weak
Abrasion of fibers
Loss of stretch
Cuts – Burns
Dirt between inner fibers
Freezing of rope

12.11 Synthetic Rope

- (a) Synthetic fiber ropes are made from nylon, polypropylene, or polyester. Synthetic fiber ropes consist of individual threads and fibers that run the full length of the rope (natural fibers are not continuous – in fact, they are short and overlapped).
- (b) Do not choose synthetic rope when burning and welding. Synthetic rope is also more likely to be affected by chemicals and it tends to be slippery.
- (c) Do not use clamps for splicing synthetic rope unless it is specifically designed for this purpose.

Figure 12af

INSPECTING MANILA ROPE



Safe Practice Rules

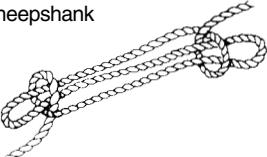
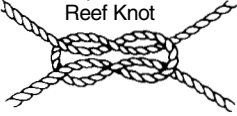



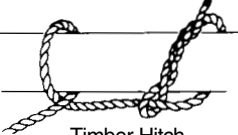



1. Frozen fiber rope shall not be used in load carrying service.
2. Fiber rope that has been subjected to acids or excessive heat shall not be used for load carrying purposes.
3. Fiber rope shall be protected from abrasion by padding where it is fastened or drawn over square corners or sharp or rough surfaces.

- (d) Good practices when using synthetic rope:
 - (1) Keep rope dry and clean and away from chemicals
 - (2) Never overload a rope
 - (3) Never use a frozen rope
 - (4) Don't drag a rope on the ground. This will damage the outside surface of the rope.
 - (5) Never allow the rope to bend over sharp edges
 - (6) Don't permit the rope to drag against itself
 - (7) Observe proper picking angles
 - (8) Pad all corners when lifting materials
 - (9) When coupling ropes, use thimbles
 - (10) Inspect rope often by twisting to expose the inside yarns
- (e) Synthetic rope shall be removed from service if it shows signs of:
 - (1) Abnormal wear
 - (2) Powder between strands
 - (3) Broken or cut fibers
 - (4) Variations in the size or roundness of strands
 - (5) Discoloration or rotting
 - (6) Distortion of hardware
- (f) When rope is damaged and taken out of service, it shall be completely destroyed to prevent others from using it.

12.12 Knots Are Weak

If a knot or hitch of any kind is tied in a rope, its failure under stress is sure to occur at that place. Each fiber in the straight part of the rope takes proper share of the load. In all knots, the rope is cramped or has a short bend, which throws an overload on those fibers that are on the outside of the bend, and one fiber after another breaks until the rope is torn apart. The shorter the bend in the standing rope, the weaker the knot. The results given in Figure 12ag are approximate, but are sufficient to cause caution in all rope fastenings employed in important work.

Figure 12ag Approximate Efficiency – Comparison of Rope Knots and Connections to Safe Load

<p>Sheepshank</p>  <p>35%</p>	<p>Square or Reef Knot</p>  <p>43%</p>
<p>Bowline (outside)</p>  <p>50%</p>	<p>Bowline (inside)</p>  <p>53%</p>
<p>Long Splice</p>  <p>68%</p>	<p>Timber Hitch & Half Hitch</p>  <p>72%</p>
<p>Short Splice</p>  <p>85%</p>	<p>Clove Hitch</p>  <p>75%</p>
<p>Eye Splice</p>  <p>85%</p>	

Source: Handbook for Riggers, 1977 Revised Edition

Note: Variations in test equipment, procedures, rope age, condition and construction, etc. may impact test results. The efficiencies shown above are for point of reference only. **Rigging methods, rope capacity, etc. shall well exceed the weight of the load to be hoisted. Knot efficiencies shall not be factored into the lift too closely; err on the side of caution.**

Figure Eight Knot

Used in the end of a rope to temporarily prevent the strands from unraveling. Useful to prevent the end of a rope from slipping through a block or an eye, and does not jam as easily as the overhand knot.

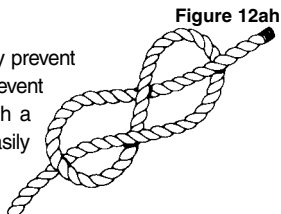
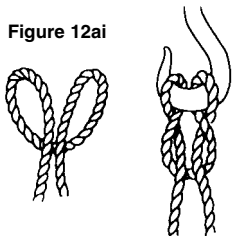


Figure 12ah

Figure 12ai



Catspaw

Used to secure the middle of a rope to a hook. Take two bights (loops) in the rope, twist in opposite directions and then bring the loops together and pass over hook.

Timber Hitch

(A) Used for hoisting planks, timbers and pipe. Holds without slipping and does not jam. A half-hitch is added in (B) This is done to keep a plank or length of pipe on end, while lifting.

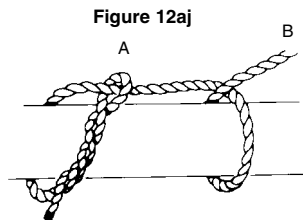
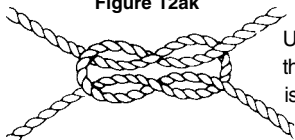


Figure 12aj

Figure 12ak



Reef Knot or Square Knot

Used to join two ropes or lines of the same size - holds firmly and is easily untied.



Figure 12al

Bowline on the Bight

Used in emergencies to lift an injured person off a building or out of a hole. This is accomplished by sitting in one loop, and putting the other loop around the back and under the arms. Also used to tie bowline in middle of line.

Figure 12am

Clove Hitch or Builder's Hitch

Because of its wide use by construction workers in fastening rope to upright posts on staging to act as a rail or warning line, it is also known as a builder's hitch. Making a line fast is another common use.

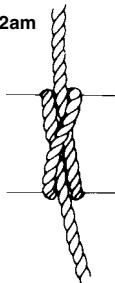
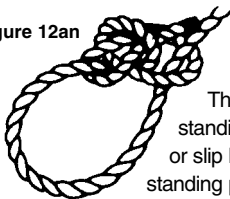


Figure 12an

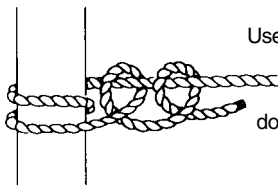


Running Bowline

This is merely a bowline knot made round the standing part of a rope to form a running noose or slip knot and is very reliable. Runs freely on the standing part and is easily untied. **This knot shall not be used for securing lifelines.**

Figure 12ao

Round Turn and Two Half Hitches



Used to secure a rope to a column or post, and will stand heavy strain without slipping. Easily tied and does not jam.

Figure Eight on a Bight

Provides a secure loop in the end of a rope. Made by doubling a line back on itself and then tying a Figure Eight knot in the double line. This knot may reduce the strength of a rope by 20%. **This knot shall not be used for securing a lifeline.**

CAUTION: Be certain you tie a Figure Eight, not an Overhand on a Bight.

Figure 12ap

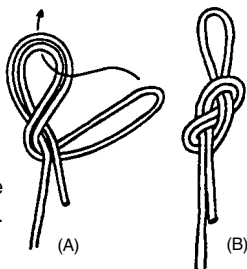
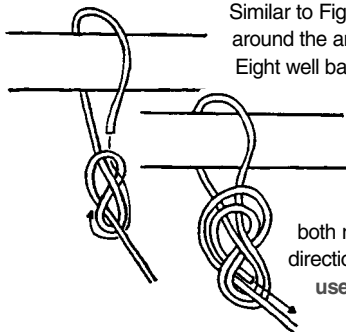


Figure 12aq

Figure Eight Follow Through



Similar to Figure Eight on a Bight, but is tied around the anchor point. Tie a simple Figure Eight well back from the end of the rope.

Pass the end of the rope around the anchor point then follow back through parallel to the first knot. Follow every contour of the first knot with both rope ends going in the same direction. **This knot shall not be used for securing a lifeline.**

Bowline

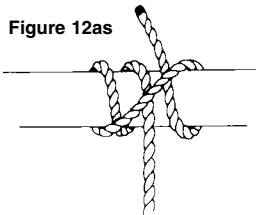
One of the best-known and most-widely used of all knots. A favorite knot with riggers, it is easily constructed and used wherever a hitch is required that will not slip, jam or fail. (Hint: Leave a long tail and secure the tail with two half-hitches.) **This knot shall not be used for securing a lifeline.**



Figure 12ar



Figure 12as



Rolling Hitch

This knot is used for lifting round loads, such as pipe or bar steel. For a more efficient knot, add half-hitch, short end around long end.

Carrick Bend

Used for joining large ropes together, and easier to untie than most knots after being subjected to strain.

Figure 12at

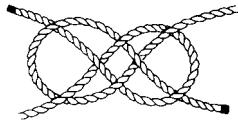
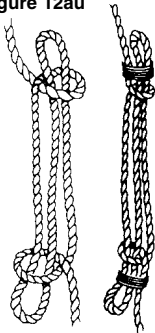


Figure 12au



Sheepshank

This knot is used for shortening a rope. The method shown is especially useful where the ends of the rope are not free, as it can be employed in the center of a tied rope. Taking the strain off a damaged piece of rope when there is not time to immediately replace with sound rope is another use. When seized, as shown, it is more secure.

Section 13

WELDING, CUTTING AND SOLDERING

13.1 General Precautions

- (a) Local regulations or contract requirements may require a permit or license before using portable cutting or welding equipment.
- (b) Move combustible material to a safe area. If combustible material can't be moved, cover completely with fire-retardant material.
- (c) Provide a fire watch to make sure fires do not start. Have a fire extinguisher readily accessible where employees are working. Extinguishers shall be of ABC type, minimum 2A:20BC rating.
- (d) Never burn or weld over other workers.
- (e) After completing a burning or welding operation, monitor the scene of work for fires. Inspect adjacent areas as well.
- (f) Use only non-flammable PVC glue to bond in-ground PVC hydraulic jack liners to prevent explosion hazard resulting from welding or burning operations. **NEVER WELD OR BURN IN OR OVER AREAS WHERE FLAMMABLE AGENTS ARE PRESENT.**
- (g) Do not use cutting or welding equipment near flammable liquids. Do not cut or weld on closed tanks which have held flammable liquids or other combustibles.
- (h) Ensure there is sufficient ventilation to remove potentially toxic fumes in areas of concern.

- (i) Never use empty containers such as drums as a work station. They may contain potentially hazardous fumes. Consideration should be given for air monitoring by qualified personnel.
- (j) Keep cutting and welding equipment in good operating condition at all times. Equipment found to be defective shall be tagged immediately and returned to the shop for repair.
- (k) Operators shall never wear oil-stained clothing.
- (l) Always hold lighted acetylene and propane torches – do not lay them down or hang them on beams or planks. A safe area shall be selected for resting a live electrode holder before striking an arc.
- (m) Do not burn or weld in hoistways, where rails or other equipment are covered with oil or lint.
- (n) Assure proper ventilation is provided for gas welders.
- (o) Torch valves should be opened to vent pressure from the line and shut again.
- (p) Use proper eye protection when welding, cutting and chipping. Reference Personal Protection Equipment – see Section 3.
- (q) Wear a leather jacket or equivalent material to protect your skin from burns due to metal splatter and UV radiation.
- (r) Use welding gloves to protect your hands
- (s) Leather chaps are recommended to protect your legs and vital parts.
- (t) When welding and cutting be aware of other people in the area. Advise them to look away when welding.
- (u) Be aware of falling splatter, hot slag and sparks.

13.2 Acetylene, Oxygen and Other Pressurized Fuel Cylinders

Acetylene and oxygen cylinders are under high pressure and shall be handled with extreme care. Cylinders shall be kept in an upright position, either on a tank cart or tied to a vertical building member, such as a building column. Never lay cylinders down.

- (a) Valve handles or valve wrenches shall be retained in place while cylinders are in use.
- (b) Check all connections for leaks.
- (c) Keep hose in the clear so that it cannot be damaged.
- (d) Protect gauges and torches from damage.
- (e) Keep cylinders away from work areas so that sparks cannot reach them.
- (f) Oil and grease shall never be used on or around welding and cutting equipment.
- (g) The use of regulators and flash arrestors are mandatory.
- (h) Do not use oxygen to blow out or clean equipment.
- (i) Do not take cylinders into elevator pits; keep them in a well-ventilated area.
- (j) Do not lift cylinders by their protective caps.
- (k) Propane and butane are heavier than air, and highly explosive. Guard against leaks when using this equipment. Use only in well-ventilated areas. Unburned gas from even a small leak will settle in pockets such as elevator pits, stairwells or other areas.
- (l) Shut off valves and purge all hoses immediately after each use.
- (m) Cylinder caps shall be in place whenever cylinders are not in use, being moved, or while they are in storage.
- (n) Acetylene and oxygen cylinders can be temporarily kept in a hand cart if they were used in the current 24 hour period.

- (o) When not in use, oxygen and acetylene cylinders shall be stored at least 20 ft (6.1 m) apart, or separated by a one-half-hour (30-minute) rated fire-resistive wall or partition at least 5 ft (1.5 m) high, and shall be secured to prevent tipping.
- (p) Empty cylinders shall be marked "MT."
- (q) Cylinders shall never be stored in gang boxes.

13.3 Soldering

- (a) Solder containing lead shall not be used.
- (b) Be careful of splatter.
- (c) Burns from hot solder are painful and may lead to infection. Treat all burns immediately.
- (d) Wear a face shield, especially if you are soldering overhead. See Section 3.2.
- (e) Keep shirt collar buttoned.
- (f) Wear a long sleeve shirt and button the cuffs.

Section 14

HAZARD COMMUNICATIONS (HAZCOM)

14.1 Working With Chemicals

The OSHA Hazard Communication (HAZCOM) (Right-To-Know) Standard requires all employees be given adequate information and training on the long- and short-term health effects of chemicals they work with. Your company has established a Hazard Communication (HAZCOM) Program to provide this information to you. You can take the steps necessary to safeguard your health by following the procedures established in this program.

A copy of this program – along with a chemical inventory list and corresponding Material Safety Data Sheets (MSDSs) are available for your review and is required to be kept at your local office and at all construction and major modernization jobsites or any other sites where you spend a full shift or eight hours. This program may be made available to others upon request to your Superintendent/Manager.

Chemicals affect the human body differently. The physical makeup of the chemical, the amount of exposure (time and quantity), and the manner in which the chemical is absorbed by the body all play a role in the resulting effects. As long as exposures are not excessive, many potentially dangerous substances are eliminated naturally from the body. It is important to remember that most materials can be removed this way, and their effects are usually not cumulative.

What is important is the dose or amount of a particular chemical that is absorbed over a period of time. Too much of a chemical, either all at once or over time, may be dangerous. Chemicals are absorbed into the body in three ways:

- (a) Inhalation – The chemical is taken in with the air we breathe, either as a vapor, dust, gas, fume or mist.
- (b) Ingestion – The chemical is ingested either intentionally or accidentally. It can be taken in with the food you eat (or drink) especially if you fail to wash your hands before eating or smoking.
- (c) Absorption – It is absorbed through the skin. This occurs for only a limited number of chemicals.

Inhalation is by far the most common way in which chemicals enter the body. How much enters and is subsequently absorbed through the lungs is a function of the chemical. The human respiratory system is extremely effective at removing dust from the air that is breathed. Only the smallest particles reach the lungs. The majority are trapped in the nose and throat, and later eliminated.

The amount of liquid chemicals entering the lung depends on how fast the liquid evaporated into the air. This is a function of the surrounding (ambient) temperature and the vapor pressure of the liquid (the higher the vapor pressure, the faster the evaporation rate). How much is absorbed varies with each chemical.

Industrial Hygienists are engaged in the science of protecting workers from the harmful effects of chemicals. They are trained to recognize, evaluate and control potential exposures to chemicals in the workplace. Today, many chemicals have been studied, and as a result, their effects have been identified. Levels of acceptable exposure for a normal work day have been determined. These are known as threshold limit values (TLV), or permissible exposure limits (PEL).

In general, there are two major types of effects which are of concern when talking about chemical exposure – the short term or acute effects, and the long term or chronic effects. Some chemicals have both, some one or the other.

Asbestos is an example of a substance that can result in chronic health effects. Asbestos fibers enter the body through inhalation of airborne asbestos particles and can become embedded in the tissues of the respiratory or digestive systems. Diseases associated with asbestos exposure often do not manifest themselves for 25-35 years following the start of exposure. The risk of disease is significantly increased when both asbestos exposure and smoking occurs.

Most acid gases exhibit only acute health effects. Exposure to acid gases can be extremely irritating, causing a sore throat, coughing and tearing of the eyes. However, once exposure stops, the effects generally pass with no lasting results. The exposure limits are designed to eliminate both short- and long-term symptoms.

Information on a particular chemical (or mixture of chemicals) can be found on the Material Safety Data Sheet (MSDSs) for that chemical. This gives the trade name, manufacturer, chemical components, exposure limits, effects of exposure, precautions to follow, as well as data on the vapor pressure, flammability, etc., and other physical data.

If you wish to know about a specific chemical you work with, talk to your Superintendent/Manager, review the MSDSs and discuss the procedures for handling the chemical established by your Elevator Company. Fortunately, most chemicals used in the elevator industry are of low toxicity, but like any chemical, must be used correctly to avoid hazardous conditions.

14.2 Oils and Grease

OSHA has established an exposure limit of 5 milligrams per cubic meter (mg/m^3) for oil mist in air. In the elevator industry, exposure results from physically handling the oil. Airborne exposures are virtually nonexistent. The biggest potential hazard results from contact with the oil (especially used oil) on the

skin. Use gloves where appropriate. Always wash your hands when they become oily – use soap and water.

14.3 Cleaners

Check the label on the container or the MSDS for the appropriate personal protective equipment to wear prior to working with any chemicals.

Three main types of cleaners are found in the elevator industry.

14.3.1. Petroleum Naphthas

- (a) These are petroleum distillates or naphtha-based cleaners commonly used for oil and grease removal. They have a relatively low volatility (do not evaporate fast) and low toxicity. They have an odor like gasoline or kerosene and are generally used in a liquid form, but may also be found in aerosol form.
- (b) Petroleum naphtha cleaners and vapors are flammable. They shall not be used around open flames, welding operations or other ignition sources. Exposure to high vapor concentrations can cause irritation of the eyes, nose and throat, nausea and headaches. Care should be taken to avoid using these materials in areas with inadequate air movement where the vapors can accumulate; ensure proper ventilation before, during and after use.
- (c) Excessive skin contact can cause defatting of the skin, which can lead to skin irritation. Good personal hygiene practices and the use of personal protective equipment (PPEs), such as rubber or neoprene gloves and chemical goggles, can minimize exposure.

14.3.2 Hydrocarbons

- (a) These have been used for cleaning electrical components such as controllers and motors. Due to the inherent safety issues with hydrocarbons, water-based cleaners shall be

used. They are usually found in aerosol form. There are two forms of hydrocarbon cleaner: halogenated and non-halogenated.

- (b) Halogenated hydrocarbons contain a high percentage of chlorofluorocarbons (CFCs), various combinations of fluorine and chlorine. Examples of CFCs found in halogenated hydrocarbon cleaners used in the elevator industry include 1,1,1-Trichloroethane (methyl chloroform), Trichloro-trifluoroethane (Freon 113), and dichlorodifluoromethane (Freon 12).

14.3.3 Water-Based Cleaners

- (a) Water-based cleaners are being used as an effective substitute for petroleum naphtha cleaners to remove oils and grease, but without the potential fire and health hazards posed by the chemical compounds found in the petroleum naphthas. Water-based cleaners are generally used in a liquid or semi-liquid (gel) form. They are also available for cleaning electric contacts (e.g. Simple Green, etc.).
- (b) Although the most prevalent ingredient in these cleaners is water, precautions are necessary. Repeated and prolonged skin contact can remove the oil from the skin, leading to irritation and possible infection. Good personal hygiene and the use of gloves and chemical goggles will limit exposure.

14.4 Babbitting

Babbit contains lead, which is a highly toxic material and shall be handled correctly. The primary route of exposure is through the inhalation of fumes, though ingestion can be significant if hands are not washed before eating or smoking. Repeated overexposure can result in elevated concentrations in the body, which is slowly eliminated when exposure ceases.

Significant lead fumes are only released when the lead approaches its boiling point, over 1000°F (537.8°C) which is well above the temperature used in babbiting operations, around 400°F (204.4°C). Adequate ventilation shall also be provided. Chronic overexposure to lead may cause damage to the blood-forming, nervous, urinary and reproductive systems of the body. Symptoms include loss of appetite, metallic taste in the mouth, excessive tiredness, constipation, nausea, nervous irritability, joint pain, tremors, weakness and dizziness.

- (a) Use wedge shackles when ever possible.
- (b) Protective face shields and gloves shall be worn while pouring babbit.
- (c) Preheat the bearing housing or shackle to be poured to be sure that it is dry. The presence of moisture will form captured steam and the hot babbit will explode.
- (d) Avoid breathing fumes. Melt and pour babbit in well-ventilated areas.
- (e) Wash hands prior to eating or smoking after handling babbit.
- (f) Do not use cutting torches to melt babbit. An electric melting pot shall be used, as it will not allow babbit temperatures to exceed a safe level.
- (g) Care shall be taken when using resins for socketing. Use only Company-approved heaters for curing. Do not allow the material to come into contact with exposed skin. Do not store the material in direct sunlight.

14.5 Painting

- (a) Some paints contain solvents that can be combustible or flammable. Some spray containers have flammable propellants. Some paints have undesirable odors.
- (b) Use spray paint only in well ventilated areas.
- (c) Field employees shall only use paints approved by their company. Follow the training you have been given and

follow the instructions for use on the container label. If you have concerns, contact your supervisor and review the material safety data sheets to be certain no hazard exists to yourself, fellow employees or the public.

14.6 Welding

- (a) Welding produces fumes from the metals being joined and the welding rods being used. In addition, radiation from the arc can damage the eyes, so appropriate goggles or a welding mask or hood shall always be used.
- (b) In the elevator industry, iron oxide fumes are the primary exposure encountered. The recommended exposure level is 5 mg/m³ (even in industrial environments where welding operations are continuous this level is seldom exceeded). Overexposure can cause welding fume fever which causes flu-like symptoms. Welder's exposure is further reduced by the welding mask or hood.
- (c) In cases where welding is to be performed on painted surfaces, the paint shall first be removed, using your company's approved method, in case the paint contains lead, which can rapidly vaporize during the welding process. Adequate ventilation must always be provided. (See Section 13.)
- (d) A MSDS is required for welding rods.

14.7 Asbestos

- (a) The term "asbestos" refers to a number of naturally occurring silicate materials. Asbestos in the forms of sprayed-on fireproofing, pipe insulation and acoustical plaster was used in commercial and residential buildings until the mid-to-late 1970s, when its use was banned.
- (b) The presence of asbestos-containing materials does not, in itself, present a health risk. Only when asbestos becomes airborne does it pose a potential hazard. Asbestos, con-

taining materials that are susceptible to contact, water damage and/or air flow are more likely to result in fibers being released. Only approved testing methods can determine whether asbestos is present, and at what levels.

- (c) Employees shall not perform any construction, maintenance or repairs in areas where there is a potential exposure to Presumed Asbestos Containing Material (PACM) or Asbestos Containing Material (ACM) in excess of the Personal Exposure Limits or in regulated areas in the normal scope of their work without first receiving the proper training and personal protective equipment for the type or class of work to be performed. If any employee is asked to enter such areas they shall first contact their supervisor for instructions, before entering the areas. Employees shall not, under any circumstances intentionally disturb, remove or clean up asbestos containing material without first contacting their supervisor.
- (d) **CAUTION** when drilling in doors that you suspect contain asbestos, special training and work practices are required. Contact your supervisor.

14.8 Flammable Liquids and Solvents

- (a) ONLY NON-FLAMMABLE PVC GLUE SHALL BE USED FOR BONDING SECTIONS OF IN-GROUND PVC HYDRAULIC JACK LINERS.
- (b) When using paints, solvents and chemicals, read the warning labels, appropriate MSDSs and follow instructions.
- (c) Avoid getting solvent on clothing. If clothing becomes contaminated, it shall be changed immediately.
- (d) Flames, sparks or any other ignition source shall be kept away from flammable liquids and their vapors. Smoking is prohibited in areas where such materials are used or stored, and "No Smoking" signs shall be posted in these areas.

- (e) Flammable liquids shall not be transferred from one container to another unless electrically interconnected.
- (f) Store in properly labeled safety cans or in original container if one gallon or less.
- (g) Flammable and combustible materials shall not be stored in areas used for exits, stairways or areas normally used for the safe passage of people.
- (h) Be sure there is adequate ventilation when storing flammable or combustible materials.
- (i) No more than 25 gal. (90.84 L) of such materials shall be stored in a room, unless an approved safety storage cabinet is provided.

14.9 Carbon Dust

Most electrical brushes expel carbon dust onto machine room equipment. When cleaning components, avoid irritation to skin and breathing passageways. You may want to consider wearing a dust mask and latex gloves or use a closed system (bonnet). Safety glasses/goggles are also required if liquid cleaning agents are being used.

14.10 Sulfuric Acid Type Batteries

- (a) Batteries may contain sulfuric acid and as such shall be handled with care. The acid is contained in a gel media and is not subject to leaking (unless case is cracked), however at high temperatures (greater than 140° F) the gel may liquefy causing leakage. Similarly discharged batteries may freeze at temperatures below 10° F which can crack the case and cause subsequent leakage.
- (b) Sulfuric acid is corrosive and can cause burns to the skin and eyes. Fumes can cause eye, nose and throat irritation, but significant fumes would only be generated in unusual circumstances if the battery were to become overheated.

- (c) Always use personal ground straps to dissipate static discharge if you must handle hot batteries. Battery cabinet shelves are to be lined with plastic to prevent leaking batteries from eating the shelf which, if undetected, may cause it to collapse.

NOTE: Sixteen 12V batteries in a series can generate up to 192 volts. Remember disconnecting the main line switch does not protect you. Use proper gloves and insulated tools and follow safe electrical work practices.

- (d) When working on or in rooms with sulfuric acid batteries the following items shall be kept onsite/inside the elevator machine room:
 - (1) One (1) Pair of Rubber Gloves
 - (2) One (1) Pair of Safety Goggles
 - (3) One (1) Spill Kit
 - (4) One (1) Rubber Apron
 - (5) One (1) Face Shield
 - (6) One (1) Eye Wash Kit
 - (7) One (1) Bottle of Sterile Water
 - (8) One (1) Box of Baking Soda
- (e) In addition, it is recommended that the proper warning signage be posted on the machine room door.
- (f) When handling or testing batteries, you shall wear gloves, apron and full face shield (and goggles) to avoid contact with acid which may leak from the battery.
- (g) If acid gas/fumes are detected, immediately exit the room and notify your supervisor.
- (h) Acid gas/fumes are readily detected by an irritation in the nose and throat.
- (i) As charging produces hydrogen which readily burns, machine rooms should be well ventilated to prevent hydrogen build up.

- (j) Smoking, flames or sparks shall be kept away from batteries. Use personal ground straps when handling hot batteries to control static discharge.
- (k) The following procedures should be followed in case of contact with acid:
 - (1) Eyes: Flush with water for 15 minutes – use eye wash in safety kit and follow up with ordinary water if necessary. Seek medical attention.
 - (2) Skin: Flush affected parts of the body with large amounts of water, then neutralize with baking soda or sodium bicarbonate and remove contaminated clothing. If the burn is severe, go immediately to the emergency room at the nearest hospital.
 - (3) Inhalation: Remove immediately to fresh air, if dizzy or unconscious, transport immediately to the emergency room at the nearest hospital.
 - (4) Ingestion: If sulfuric acid is swallowed, DO NOT INDUCE VOMITING, wash out the mouth with water, if milk is available drink as much as possible, if not, then drink as much water as possible and go immediately to the emergency room at the nearest hospital.
- (l) Before energizing equipment, ensure doors on battery compartment are closed. There have been isolated reports of batteries exploding when first put under load.
- (m) Batteries shall not be stacked on each other as this may crack the case.
- (n) Do not clean battery cases with cleaning solvents.
- (o) Return all used batteries to local office for proper disposal.
- (p) Be aware that all bottles of eye wash and boxes of baking soda are dated and shall be routinely checked and replaced as necessary. Make certain that a currently dated eye wash bottle and box of baking soda is available.

14.11 Radio Frequency (RF) Awareness

Radio frequency (RF) exposure may be encountered during machine-room access. Be aware and obey the following safety practices.

- (a) Be aware that RF energy exists.
- (b) Obey all posted signs.
- (c) Never stop directly in front of an antenna.
- (d) The maximum permissible exposures are set approximately 10 times lower than the levels that are known to cause adverse effects. ANSI has guidelines for these limits.
- (e) Never touch an antenna. Touching un-insulated antennas or other un-insulated objects on an antenna may cause burns. Most antennas are insulated by a fiberglass coating for your protection.
- (f) Assume that all antennas are active and maintain a minimum of 3-ft. safe distance per FCC guidelines. Some communication providers recommend maintaining a 7-ft. distance from the emitting source.
- (g) As a precaution, if a pacemaker is worn, you should consult your physician before entering an outlined area around an antenna.
- (h) Effects of RF exposure do not accumulate over time.
- (i) Prolonged exposure to low levels of RF energy are not considered to be a health risk.
- (j) Prolonged exposure to sufficiently high levels of RF energy can cause a buildup of heat.
- (k) Contact your supervisor if you have concerns.

Copyright© 2006 Elevator World, Inc.

Section 15

INCLINED ELEVATORS

You shall familiarize yourself with the safety procedures outlined throughout this safety handbook. In addition, the following safety requirements shall receive special attention when working on Inclined Elevators.

- (a) Inclined elevators operate at some degree from the horizontal and present hazards not expected by persons familiar with vertical electric elevators.
- (b) The horizontal motion of the car and counterweight must always be considered as well as the fact that most inclined elevators have their counterweight operating directly below the car chassis (frame), sometime within the same guide rail. Counterweight pit guards are not required.
- (c) Inclined elevator counterweights are commonly located within the same guide rail assembly and below the car. Be extremely cautious near the mid-point of travel.
- (d) End loading inclined elevators have no runby and the car door will be extremely close to the landing door at the uphill terminal.
 - (1) There is no refuge in the direction of travel beyond the terminals.
 - (2) Keep all parts of the body and any tools inside the car when in motion.

Section 16

ESCALATORS AND MOVING WALKS

You shall familiarize yourself with the safety procedures outlined throughout this safety handbook. In addition, the following safety rules shall receive special attention when working on escalators or moving walks:

- (a) Mechanics arriving at a location shall alert the owner or superintendent and place company-approved “Out of Service” signs and sufficient and proper barricades at both ends of escalators and walks to restrict all non-authorized persons from entering the work area or stairways. (See Section 4.3)
 - (1) When step, step-treads, pallets, combplates, combplate teeth, floor plates or trap doors have been removed, and power is not required for the equipment it shall be locked out and tagged out with barricades in place at both ends.
 - (2) Unattended equipment shall always be locked and tagged out.
- (b) Before work begins, the mechanic shall instruct all employees inexperienced with escalator or moving walk service on the location of the emergency “STOP” button and safety switches.
- (c) Communicate with all employees before moving an escalator or walk. Repeat commands or direction signals. Make sure their actions show they understand your message.
- (d) NEVER start, or attempt to start, a unit while anyone is on or in the unit.
- (e) Whenever service must be performed within the interior plane of the steps/pallets that does not require movement of the unit, lockout and tagout the mainline power discon-

nect in the “OFF” position. Before you enter the unit or pit, personally verify that the unit will not start by testing all locations and possible combinations of the run and speed key-start switches. See Lockout and Tagout procedures, Section 7.3.

- (f) Be aware that the 110-volt power supply may still be live at the junction box, even after the mainline power has been disconnected. Use a circuit tester to test all circuits before working on them.
- (g) While working on escalators or walks, the holding or maintaining circuit shall be opened so that the person in attendance has complete control of the equipment. This is normally done by a switch being turned to an “INSPECT” position, which changes the start switch to a “deadman control” switch. To move the unit in the “INSPECT” mode, someone will have to hold the key switch in the “ON” or “START” position.
- (h) Separate your escalator- or moving-walk-start keys from your key ring. The weight of a full ring of keys can hold a key switch over in the “ON” or “START” position, which overrides the safety circuit. If you try to stop the unit, the key would re-start the unit immediately.
- (i) When running a unit in an “INSPECT” mode, only one key switch is operable while the opposite end is locked out.
- (j) Always remove the start key from the switch when you do not need it, especially when you are leaving the area.
- (k) When removing steps or pallets, use proper lifting techniques.
- (l) When working on or around moving equipment, take precautions to avoid getting yourself, or a tool, caught or pulled into the equipment. Be aware of all pinch points. Never attempt to remove a foreign object from an escalator or moving walk with the unit in operation.

Copyright© 2006 Elevator World, Inc.

- (m) When walking on a partially disassembled unit, avoid walking on the step axles as much as possible. Always hold the handrail. The unit shall be electrically locked out and blocked (See Section 7.3)
- (n) Do not “inch” equipment unless the holding circuit has been opened.
- (o) When any steps or pallets are removed, always work, or if necessary, ride behind the opening.
- (p) It is recognized that temporary circuit jumpers or clips may be the only means available for conducting some service work on escalators or moving walks. These devices shall only be used as a last resort. (See Section 6.)
- (q) Before leaving the building, if the unit is to be returned to service, remove all “Out of Service” signs. Checkout with the Building Superintendent/Manager.

Section 17

DUMBWAITERS

You shall familiarize yourself with the safety procedures outlined throughout this safety handbook. In addition, the following safety rules shall receive special attention when working on dumbwaiters.

- (a) Never ride or stand on a dumbwaiter, unless the rated load exceeds your weight, plus the weight of your tools. The cab must also be structurally capable of holding your weight, plus the weight of your tools before you access the top of the car, even if the car is secured as described below.
- (b) Before riding or standing on a dumbwaiter, ensure the following safety precautions are in place:
 - (1) Ensure the dumbwaiter is equipped with a functioning top-of-car operating station.
 - (2) Ensure the top-of-car emergency stop switch is operating. (See Stop Switch Procedure Section 8.1.)
 - (3) Verify the dumbwaiter is equipped with safeties.
 - (4) Always ride on top of the dumbwaiter and never inside the car.
 - (5) Observe overhead clearance.
- (c) If work must be performed on top of the car and any one of the five safety precautions above are not present, other methods of securing the car shall be employed. Initiate the Lockout and Tagout Procedure in Section 7.2 and secure the car from the overhead, or block the car from below in such a manner that the car will hold your weight, plus the weight of your tools.
- (d) When working from the car top, be extremely careful that your body is within the confines of the car and clear of all hoistway protrusions while running.

- (e) Make sure all operating devices are inactive (push buttons, automatic-leveling and homing circuits, etc.), except those under your immediate control.
- (f) Check turnbuckles on car and counterweight ropes to be sure they are double-nutted and pinned. Wire rope has a tendency to twist when operating over sheaves and will spin nuts off turnbuckles if they are not secured.
- (g) Never leave a hoistway door open or unlocked at a landing when the car is not there, level or under conditions where the car can move, unless the opening is guarded by a Competent Person.
- (h) Check for adequate overhead and under-the-car clearance before getting on top of car or in the pit.
- (i) Do not enter pit unless mainline power switch has been disconnected, locked out and tagged out. (See Section 7.2.)
- (j) On dumbwaiters with automatic-transfer devices, be sure all such units are within the car before running.
- (k) When working through an open hoistway door or the machine room door and the car is moved, be careful to avoid contact with the car-gate spreader.

SECTION 18

SERVICE AND REPAIR JOB HAZARD ASSESSMENT

18.1 Instructions

OSHA requires each employer to assess the workplace to determine if hazards are present, or likely to be present, which necessitate the use of Personal Protective Equipment (PPE). Currently, this regulation does not apply to construction.

18.2 Overview

PPE is designed to aid in the protection against work and environmental hazards that cannot be eliminated. The Occupational Safety and Health Administration (OSHA) requires employers to conduct a “hazard assessment” for the workplace. The survey results can serve as the basis for establishing PPE requirements for all similar jobs.

In 1997, the NEII Safety Committee developed the Service and Repair Job Hazard Assessment Form to help the industry facilitate compliance with the OSHA regulations specified above. The Service and Repair Job Hazard Assessment Form (NEII SC01) shall be utilized in conjunction with the *Elevator Industry Field Employees' Safety Handbook* and is intended to help your company and you comply with the OSHA PPE Standard.

18.3 General

All equipment shall be company approved and designed for the work to be performed. All PPE equipment shall be used and maintained in a sanitary and reliable condition. These provisions apply to all field personnel, management personnel and visitors.

18.4 Foot and Leg Protection

- (a) All footwear shall meet industry and company requirements and protect the worker from falling, rolling or sharp objects, wet slippery surfaces and potential electrical hazards.
- (b) Leggings protect the lower leg and feet from welding sparks. Safety snaps allow them to be removed quickly. Knee guards may be required if the worker is exposed to extended kneeling. (Also see Section 3.4)

18.5 Head Protection

- (a) OSHA regulations mandate that all workers wear protective helmets in areas where there is a possible danger of head injury from impact, falling or flying objects, or electrical shock and burns.
- (b) Each worker is required to comply with both industry and company standards on when, where and how to fit and wear hard hats. Hard hats shall comply with the “American National Standards Safety Requirements for Industrial Head Protection,” ANSI Z89.1-1986, which shall be marked on the helmet’s shell. (Also see Section 3.3)

18.6 Hearing Protection

- (a) OSHA has established permissible noise levels and duration of exposure for workers. When noise levels or exposure cannot be reduced to below the permissible noise level, ear protection devices shall be provided and worn.
- (b) To be effective, the device used shall be properly fitted. Some earplugs are disposable and should be discarded after one use. Nondisposable earplugs shall be cleaned after each use. (Also see Section 3.5)

18.7 Eye and Face Protection

- (a) Eye and face protective equipment shall be provided when there is a potential for injury from flying particles, liquid chemicals, gases, electrical shock/arcing and radiant energy. Companies are required to provide a type of eye protection suitable for the work to be performed.
- (b) Eye and face protection can include goggles, glasses and face shields. Eye protection devices shall comply with the “American National Standard Practice for Occupational and Educational Eye and Face Protection,” ANSI Z87.1-1989. (Also see Section 3.2)

18.8 Respiratory Protection

- (a) The company shall provide appropriate respiratory devices, where required. They are to be used by all affected workers in accordance with the company’s respiratory program.
- (b) All respiratory devices shall be approved by the Department of Health and Human Services National Institute for Occupational Safety and Health for the contaminant or situation to which the worker is exposed. (Also see Section 3.8)

18.9 Personal Fall Arrest System

The company shall provide each worker an appropriate personal fall arrest system to be used, where required. Safety harnesses, lifelines and shock-absorbing lanyards shall be used when guardrails and safety nets are not available or feasible, and there is a fall exposure over six feet. (Also see Section 3.6 and 4.1)

18.10 Hand Protection

If there is a potential for cuts, abrasions, burns and skin contact with chemicals, gloves, suitable for the hazard, shall be worn. (Also see Section 3.7)

18.11 OSHA Regulations

A job hazard assessment for PPE is required by 29 CFR Subpart 1, Section 1910.132 through 138. Additional PPE requirements can be located in 29 CFR Subpart E, Section 1926.95 through 107 and other regulations, such as Subpart G, K and M. The Service and Repair Job Hazard Assessment establishes the minimum PPE requirements for elevator industry personnel performing service and repair work.

18.12 Competent Person

OSHA requires that the company analyze specific PPE requirements for workers on each job or project. A Competent Person (superintendent, field engineer, mechanic or mechanic-in-charge) must review the job prior to startup to identify additional hazards. A Job Hazard Assessment is required to be completed by a Competent Person. (See Section 21.)

18.13 Assessing Workplace Hazards

The employer shall assess the workplace hazards to determine where PPE is required. Use of the Service and Repair Job Hazard Assessment Form (NEII SC01) is recommended to help the elevator company comply with OSHA regulations. The assessment process is outlined as follows:

- (a) A Competent Person shall conduct a hazard assessment to identify hazards which require PPE and/or to verify the PPE used by the worker is sufficient. This

shall be noted and documented as written certification of the assessment.

- (b) Select, and have each affected employee use, the types of PPE that will protect the affected employee from the hazards identified in the hazard assessment.
- (c) Issue and train each employee on the use and care of the required PPE and insure that each employee has properly fitted PPE.
- (d) Appropriate equipment shall be issued to the employee prior to startup or at new-hire orientation by the employer. The employee may be required to provide some PPE.

18.14 Training

OSHA requires the company to provide training to each employee who is required to have PPE and to know:

- (a) when PPE is necessary;
- (b) what PPE is necessary;
- (c) how to properly wear, fit, adjust and remove PPE;
- (d) the limitations of the PPE; and
- (e) the proper care, maintenance, useful life and disposal of the PPE.

If the company has reason to believe the trained worker does not have the understanding and skill required by the company to use the PPE, the company shall remove the worker from the job until the worker is adequately trained.

Each company is required to certify that each worker has been trained or retrained if there is a job assignment change which presents a new hazard, or the need for retraining is identified. Documentation on the date, type of training and worker's name should be retained as documentation.

Figure 18a

Page 1 of 2

Top of Car
 Pit
 Inside of Car

Outside of Car (Landing)
 Escalator/Moving Walk
 Machine Room

Date: _____
Job: _____
Prepared By: _____

SERVICE AND REPAIR JOB HAZARD ASSESSMENT (MAY NOT BE ALL INCLUSIVE)

Work Location: _____ Major Tasks: _____ Steps: _____ 1. _____ 2. _____ 3. _____ 4. _____ 5. _____	Personal Protective Equipment Control (CFR 1910)					Additional Control				
	Eyes	Face	Hands/Arms	Head	Feet/Legs	Other* (Specify)				
Check if Applicable	<input type="checkbox"/>	<input type="checkbox"/>	<input type="checkbox"/>	<input type="checkbox"/>	<input type="checkbox"/>	<input type="checkbox"/>				
Safety Glasses w/Side Shields	<input type="checkbox"/>	<input type="checkbox"/>	<input type="checkbox"/>	<input type="checkbox"/>	<input type="checkbox"/>	<input type="checkbox"/>				
Safety Goggles	<input type="checkbox"/>	<input type="checkbox"/>	<input type="checkbox"/>	<input type="checkbox"/>	<input type="checkbox"/>	<input type="checkbox"/>				
Welding Glasses & Goggles	<input type="checkbox"/>	<input type="checkbox"/>	<input type="checkbox"/>	<input type="checkbox"/>	<input type="checkbox"/>	<input type="checkbox"/>				
Respirator	<input type="checkbox"/>	<input type="checkbox"/>	<input type="checkbox"/>	<input type="checkbox"/>	<input type="checkbox"/>	<input type="checkbox"/>				
Face Shield	<input type="checkbox"/>	<input type="checkbox"/>	<input type="checkbox"/>	<input type="checkbox"/>	<input type="checkbox"/>	<input type="checkbox"/>				
Welders Hood (W/Tinted Lens)	<input type="checkbox"/>	<input type="checkbox"/>	<input type="checkbox"/>	<input type="checkbox"/>	<input type="checkbox"/>	<input type="checkbox"/>				
Hearing Protection	<input type="checkbox"/>	<input type="checkbox"/>	<input type="checkbox"/>	<input type="checkbox"/>	<input type="checkbox"/>	<input type="checkbox"/>				
Cotton Work Gloves	<input type="checkbox"/>	<input type="checkbox"/>	<input type="checkbox"/>	<input type="checkbox"/>	<input type="checkbox"/>	<input type="checkbox"/>				
Cut Resistant Glove	<input type="checkbox"/>	<input type="checkbox"/>	<input type="checkbox"/>	<input type="checkbox"/>	<input type="checkbox"/>	<input type="checkbox"/>				
Rubber Glove	<input type="checkbox"/>	<input type="checkbox"/>	<input type="checkbox"/>	<input type="checkbox"/>	<input type="checkbox"/>	<input type="checkbox"/>				
Neoprene Glove	<input type="checkbox"/>	<input type="checkbox"/>	<input type="checkbox"/>	<input type="checkbox"/>	<input type="checkbox"/>	<input type="checkbox"/>				
Leather Glove	<input type="checkbox"/>	<input type="checkbox"/>	<input type="checkbox"/>	<input type="checkbox"/>	<input type="checkbox"/>	<input type="checkbox"/>				
Heat Resistant Glove	<input type="checkbox"/>	<input type="checkbox"/>	<input type="checkbox"/>	<input type="checkbox"/>	<input type="checkbox"/>	<input type="checkbox"/>				
Sleeves	<input type="checkbox"/>	<input type="checkbox"/>	<input type="checkbox"/>	<input type="checkbox"/>	<input type="checkbox"/>	<input type="checkbox"/>				
Welders Jacket	<input type="checkbox"/>	<input type="checkbox"/>	<input type="checkbox"/>	<input type="checkbox"/>	<input type="checkbox"/>	<input type="checkbox"/>				
Standard Hardhat	<input type="checkbox"/>	<input type="checkbox"/>	<input type="checkbox"/>	<input type="checkbox"/>	<input type="checkbox"/>	<input type="checkbox"/>				
Other	<input type="checkbox"/>	<input type="checkbox"/>	<input type="checkbox"/>	<input type="checkbox"/>	<input type="checkbox"/>	<input type="checkbox"/>				
Safety Shoes	<input type="checkbox"/>	<input type="checkbox"/>	<input type="checkbox"/>	<input type="checkbox"/>	<input type="checkbox"/>	<input type="checkbox"/>				
Pants/Coveralls	<input type="checkbox"/>	<input type="checkbox"/>	<input type="checkbox"/>	<input type="checkbox"/>	<input type="checkbox"/>	<input type="checkbox"/>				
Knee Guards	<input type="checkbox"/>	<input type="checkbox"/>	<input type="checkbox"/>	<input type="checkbox"/>	<input type="checkbox"/>	<input type="checkbox"/>				
Personal Fall Arrest System	<input type="checkbox"/>	<input type="checkbox"/>	<input type="checkbox"/>	<input type="checkbox"/>	<input type="checkbox"/>	<input type="checkbox"/>				
Lifeline	<input type="checkbox"/>	<input type="checkbox"/>	<input type="checkbox"/>	<input type="checkbox"/>	<input type="checkbox"/>	<input type="checkbox"/>				
Guardrails/Barricades	<input type="checkbox"/>	<input type="checkbox"/>	<input type="checkbox"/>	<input type="checkbox"/>	<input type="checkbox"/>	<input type="checkbox"/>				
Hole Coverings	<input type="checkbox"/>	<input type="checkbox"/>	<input type="checkbox"/>	<input type="checkbox"/>	<input type="checkbox"/>	<input type="checkbox"/>				
Lockout/Tagout	<input type="checkbox"/>	<input type="checkbox"/>	<input type="checkbox"/>	<input type="checkbox"/>	<input type="checkbox"/>	<input type="checkbox"/>				
GFCI	<input type="checkbox"/>	<input type="checkbox"/>	<input type="checkbox"/>	<input type="checkbox"/>	<input type="checkbox"/>	<input type="checkbox"/>				
Stop Switch Procedure	<input type="checkbox"/>	<input type="checkbox"/>	<input type="checkbox"/>	<input type="checkbox"/>	<input type="checkbox"/>	<input type="checkbox"/>				

Hazards

- Equipment Movement Car/ Escalator/Moving Walk
- Electrical
 - Energized High Voltage
 - Energized Low Voltage
 - De-energized
- Inspecting Controller
- Use of Meters
- Overhead Clearances
- Housekeeping
- Hazardous Trash
- Environmental
 - Solvents/Oils
 - Chemicals
 - Temperature
 - Spate Constraints
 - Dust/Carbon Dust
 - Noise
- Paints
- Site Conditions
 - Stairways
 - Ladders
 - Projections
 - Walking Surfaces
 - Floor Openings

Figure 18b

Page 2 of 2

Top of Car Outside of Car (Landing)
 Pit Escalator/Moving Walk
 Inside of Car Machine Room

**SERVICE AND REPAIR
JOB HAZARD ASSESSMENT
(MAY NOT BE ALL INCLUSIVE)**

Job: _____ Date: _____
 Prepared By: _____

Work Location:	Personal Protective Equipment Control (CFR 1910)						Additional Control Other* (Specify)
	Eyes	Face	Hands/Arms	Head	Feet/Legs		
Major Tasks:	CHECK IF APPLICABLE	RESPIRATOR	HEARING PROTECTION	STANDARD HARDHAT	SAFETY SHOES	PERSONAL FALL ARREST SYSTEM	
Steps:	SAFETY GLASSES W/SIDE SHIELDS	WELDERS HOOD (W/TINTED LENS)	COTTON WORK GLOVES	WELDERS JACKET	PANTS/COVERALLS	GUARDRAILS/BARRICADES	
1.	SAFETY GOGGLES	WELDING (GLASSES & GOGGLES)	CUT RESISTANT GLOVE	SLEEVES	SAFETY SHOES	HOLE COVERINGS	
2.			LEATHER GLOVE	HEAT RESISTANT GLOVE	OTHER	LOOKOUT/TAGOUT	
3.			RUBBER GLOVE	WELDERS JACKET		GFI	
4.			NEOPRENE GLOVE	WELDERS HOOD (W/TINTED LENS)		STOP SWITCH PROCEDURE	
5.			COTTON WORK GLOVES	RESPIRATOR			
Hazards							
• Site Conditions cont							
- Falling Objects							
• Mechanical Repairs							
- Blowers							
- Welding							
- Soldering							
- Cutting							
- Hoisting							
- Grinding							
- Sanding/Chiseling							
- Babbiting							
- Drilling							
- Power Accounted Tools							
- Metal Working/Handling							
- Sawing							
- Roping							
• Moving Equipment							
• Other (Specify if not all inclusive)							

* May be required to comply with other regulatory and/or company standards

Section 19

DRIVING AND VEHICLE SAFETY

Motor vehicle incidents are the number one cause of lost work time and on-the-job fatalities. Consider this: approximately 40% of all occupational deaths are motor-vehicle related.

19.1 Recognizing Hazards

Recognizing traffic hazards requires being aware of vehicles that are entering or exiting the roadway, going too fast or slow for conditions, or changing lanes. Other skills include awareness of weather conditions, traffic flow and road conditions. A driver should know what's going on ahead at least one city block, to each side, on the road behind, and inside the vehicle. Hazards include pedestrians, school buses, animals, intersections, school zones, vehicle breakdowns, cargo spills and traffic lights.

19.2 Alcohol/Drug Use

More motor vehicle fatalities are linked to alcohol/drug abuse than any other cause. It is a violation of law to operate any vehicle while impaired. **DO NOT DRINK AND DRIVE.**

19.3 Safety Belts Are For Everyone

The safety belt enables you to take control of your life. Sure, you may not be able to control that drunk driver who is headed straight for your car, but you can control your chances of surviving the crash. As long as you wear your safety belt, you are in control. Your chances of survival increase about 50%. There is no question about it, safety belts reduce fatalities and injuries. Safety belts shall be worn even if the vehicle is equipped with an airbag. **SEAT BELTS SHALL BE WORN AT ALL TIMES.**

19.4 Vehicle Maintenance

Proper vehicle maintenance is vital for safe and efficient operation. The driver of the vehicle will know best when non-scheduled maintenance is necessary. Before each trip, the driver shall check lights, mirrors, tires and brakes, and that the load is secured. Remember, safe driving doesn't happen by accident; you make it happen.

19.5 Communication Devices

Do not operate communication devices (unless hands free) while operating a motor vehicle. Pull vehicle to the side of the road and stop in a safe place before operating communication devices.

Section 20

SUBSTANCE ABUSE

- (a) No Elevator Industry employee may use or possess unlawful drugs.
- (b) You shall not bring prescription drugs on Company property or job sites, unless a licensed physician has prescribed them. Employees receiving such prescriptions in the manner, combination and quantity prescribed can only utilize such drugs.
- (c) You shall not use over-the-counter drugs that may impair your performance.
- (d) You shall not use alcoholic beverages during working hours or within six (6) hours before reporting for work and or being under the influence of alcohol while at work.
- (e) You shall not bring alcohol onto the job site for the purpose of such use.
- (f) You shall be subject to drug and/or alcohol testing following an accident on Company property or on Company business.
- (g) Any employee whose conduct, appearance or behavior may tend to suggest that the individual is impaired or otherwise not fit to perform the tasks of his or her job and is under the influence of drugs or alcohol, will be required to submit to testing as specified in their Company policy.
- (h) Employees who have failed a previous test shall be subject to unannounced follow-up testing for a period of one (1) year after their return to duty.

Section 21

GLOSSARY OF TERMS

This glossary defines various terms used in the *Elevator Industry Field Employees' Safety Handbook*.

Abatement – Elimination of workplace hazards either immediately or through a process.

Acute – Injury or illness caused by a one time exposure.

Acute Effect – Adverse effect which has severe symptoms developing rapidly and coming quickly to a crisis.

American National Standards Institute [ANSI] – A voluntary membership organization (run with private funding) that coordinates the development of consensus standards nationally and verifies that the principles of openness and due process have been followed.

ASME A17.1 Code – A code of safety standards covering the design, construction, operation, inspection, testing, maintenance, alteration and repair of elevators, escalators, moving walks and dumbwaiters. AKA Safety Code for Elevators and Escalators, ASME A17.1 an American National Standard.

Barricade – A temporary structure to restrict access to an escalator or elevator..

Bloodborne Pathogens – An OSHA Standard, 29 CFR 1910.1030, requiring Companies whose employees are exposed to human blood or other potentially infectious material to have a program that is disseminated to all employees.

Carcinogen – A substance or physical agent that may cause cancer.

Chemical – Manufactured substance used on the worksite that requires an Material Safety Data Sheet.

Chronic – Injury or illness caused by a persistent, prolonged or repeated exposure to a hazard or hazardous condition.

Chronic Effect – An adverse effect on a human body, with symptoms which develop slowly over a long period of time or which recur frequently.

Code of Federal Regulations [CFR] – Federal codes that address specific standards, including OSHA regulations.

Competent Person – A person who is capable of identifying existing and predictable hazards, on the job, in the surroundings or working conditions which are unsanitary, hazardous or dangerous to employees and who has authorization to take prompt corrective measures to eliminate them.

Confined Space – An area that has adequate size and configuration for employee entry; and has a limited means for entry and exit; and is not designed for continuous occupancy.

Do-Not-Start Tag – A company approved tag used in conjunction with the company lockout/tagout program, advising the equipment has been de-energized for maintenance or repairs.

Emergency Response – A plan to ensure employee safety in the event of fire and other emergencies that is not limited to, escape procedures and routes, employee accounting and reporting.

Environmental Protection Agency [EPA] – A Federal agency responsible for the administration of laws to control and/or reduce pollution of the air, water and land.

Equipment – elevators, escalators, dumbwaiters, moving walks, platform lifts and chair lifts.

Explosive Range – The range between the lower and upper explosive limits, expressed in terms of percentage of vapor or gas in air by volume, and is also often referred to as the “Flammable Range.”

Fall Hazard – exists when working more than 6 ft (1.8 m) above a lower level and an opening greater than 12 in. (305 mm).

Fall Protection – The use of guardrails, floor hole covers or personal fall arrest systems when a potential fall hazard exists.

False Car – A temporary movable platform assembled or built on the job-site for installing elevator equipment.

Flash Point – The lowest temperature at which a liquid gives off enough vapor to form an ignitable mixture with air and burn when a source of ignition (sparks, open flames, cigarettes, etc.) is present.

Foot Protection – Work shoes or boots that meet the company, industry and/or ANSI Z41 standard.

Ground-Fault Circuit Interrupter [GFCI] – A device intended for the protection of personnel that functions to de-energize a circuit or portion thereof within an established period of time when a current to ground exceeds 4-6 milliamps (mA).

Guardrail System – An OSHA compliant barrier installed at the entrance of elevator hoistway or around a hoistway or escalator/moving walk wellway at construction, modernization or major repair site.

Hazard Communication [HAZCOM or Right-to-Know] – A formal process to alert employees about workplace chemicals through a written program.

Hot Work Permit – See Permit.

Incident – An occurrence or event resulting in a serious injury, illness (medical treatment beyond first aid), death, environmental spill and/or near miss.

Job Hazard Assessment [JHA] – Process of analyzing each step of a task to identify hazards and corrective actions to minimize/eliminate hazards.

Jumpers – A temporary means of bypassing or shunting an electrical circuit.

Lockout/Tagout – A procedure to identify all potential energy sources and to ensure that they are completely isolated (locks and tags are attached to primary energy sources) prior to working on system.

Lower Explosive Limit [LEL] – (AKA Lower Flammable Limit). The lowest concentration of a substance that will produce a fire or flash if an ignition source (flame, spark, etc.) is present.

Material Safety Data Sheets [MSDS] – A document that identifies the hazards, safe handling and emergency procedures for each individual hazardous chemical used in the workplace.

National Institute for Occupational Safety & Health [NIOSH] – A federal agency that develops and periodically revises exposure limits for hazardous substances or conditions. NIOSH also recommends appropriate preventive measures to reduce or eliminate adverse health and safety effects of these hazards.

Occupational Safety & Health Administration [OSHA] – Federal agency under the Department of Labor that publishes and enforces safety and health regulations for most businesses and industries in the United States.

Permissible Exposure Limit [PEL] – An exposure limit that is specified in OSHA regulations. PEL may be a time-weighted-average (TWA) exposure limit (8 hour), a 15-minute short-term exposure limit (STEL), or a ceiling (C).

Permit – Written permission to proceed with an activity. A customer may require a permit (permission) prior to performing hot work (welding, grinding), entering a confined space, etc. A legal document obtained from a government agency to allow for the installation or modernization of an elevator, etc.

Permit Required Confined Space – A confined space that contains a hazardous atmosphere, mechanical or electrical hazards, limited means of entry and egress and is a serious safety or health hazard that requires air monitoring, specific training, record keeping and permit for entry.

Personal Fall Arrest System – A system used to arrest an employee in a fall from a working level. It consists of an anchorage, connectors, a body harness and may include a lanyard, deceleration device, lifeline, or suitable combinations of these. (As defined by OSHA).

Personal Protective Equipment (PPE) – Protective equipment for eyes, face, head and extremities. Including but not limited to protective clothing, respiratory devices and protective shields and barricades.

Polychlorinated Biphenyls [PCBs] – A compound derived from biphenyl and containing chlorine that is used in electrical insulators, flame-retardants, and plasticizers. PCB is a hazardous environmental pollutant that is difficult to dispose of safely.

Professional Medical Treatment – Medical treatment beyond first aid administered by a medical professional.

Qualified Person – One, who by possession of a recognized degree, certificate, or professional standing, or by extensive knowledge, training, and/or experience has successfully demonstrated his/her ability to solve or resolve problems related to the work.

Recognition of Hazards – Ability to identify hazards that have the potential to injure employees on the job.

Respiratory Protective Equipment – Devices such as respirators and masks used to protect employees from inhalation of specific dust, chemicals and solvents.

Right-to-Know – See Hazard Communication Program.

Running (Moving) Platform – The permanent structure which forms the floor of the elevator car.

Scaffolds – A temporary working platform supported by a frame that is used for the erection or repair of an elevator.

Shafter (also referred to as Spider, Go-Devil or False Car) – A moveable hoistway working platform, generally built on the jobsite for installing elevator equipment.

Shall – Indicates a mandatory requirement.

Short Term Exposure Limit [STEL] – The maximum concentration to which workers can be exposed for a short period of time (15 minutes).

Should – Indicates a recommendation not a mandatory requirement.

Stop Switch – A manually operated device that removes power from an elevator or escalator driving machine, motor and brake.

Top of Car Inspection [TOCI] – A device on top-of-the-car required by ASME A17.1 Code that permits elevator personnel to operate the elevator from the car top.

Upper Explosive Limit [UEL] – (AKA Upper Flammable Limit) The highest concentration of a substance that will burn or explode when an ignition source is present.

Section 22

APPENDICES

22.1 Metric Conversion

Figure 22a

POUNDS TO KILOGRAMS FROM 0 TO 10.9 POUNDS
(1 pound = 0.45359265 of a kilogram)

Pounds	0.0	0.1	0.2	0.3	0.4	0.5	0.6	0.7	0.8	0.9
0	Kgs 0.00000	Kgs 0.01536	Kgs 0.09072	Kgs 0.13508	Kgs 0.18144	Kgs 0.22680	Kgs 0.27216	Kgs 0.31751	Kgs 0.36287	Kgs 0.40823
1	.45359	.49895	.51431	.58967	.63503	.68039	.72575	.77111	.81647	.86183
2	.90719	.95254	.99790	1.01326	1.08862	1.13398	1.17931	1.22470	1.27006	1.31542
3	1.36078	1.40614	1.45150	1.49686	1.54222	1.58757	1.63293	1.67829	1.72365	1.76901
4	1.81437	1.85973	1.90509	1.95045	1.99581	2.04117	2.08653	2.13189	2.17724	2.22260
5	2.26796	2.31332	2.35868	2.40404	2.44940	2.49476	2.54012	2.58548	2.63084	2.67620
6	2.72156	2.76692	2.81227	2.85763	2.90299	2.94835	2.99371	3.03907	3.08443	3.12979
7	3.17515	3.22051	3.26587	3.31123	3.35659	3.40194	3.44730	3.49266	3.53802	3.58338
8	3.62874	3.67410	3.71946	3.76482	3.81018	3.85554	3.90090	3.94626	3.99162	4.03697
9	4.08233	4.12769	4.17305	4.21841	4.26377	4.30913	4.35449	4.39985	4.44521	4.49057
10	4.53593	4.58129	4.62664	4.67200	4.71736	4.76272	4.80808	4.85344	4.89880	4.94416

Figure 22b

U.S. GALLONS TO LITERS FROM 0 TO 100 GALLONS
(1 gallon = 3.7853323 liters)

Gallons	0.0	0.1	0.2	0.3	0.4	0.5	0.6	0.7	0.8	0.9
0	00.0000	3.7853	7.5707	11.3560	15.1413	18.9267	22.7120	26.4973	30.2827	34.0680
10	37.8533	41.6387	45.4240	49.2093	52.9947	56.7800	60.5653	64.3506	68.1360	71.9213
20	75.7066	79.4920	83.2773	87.0626	90.8480	94.6333	98.4186	102.2040	105.9893	109.7746
30	113.5600	117.3453	121.1306	124.9160	128.7013	132.4866	136.2720	140.0573	143.8426	147.6280
40	151.4133	155.1986	158.9840	162.7693	166.5546	170.3400	174.1253	177.9106	181.0960	185.4813
50	189.2666	193.0519	196.8373	200.6226	204.4079	208.1933	211.9786	215.7639	219.5493	223.3346
60	227.1199	230.9053	234.6906	238.4759	242.2613	246.0466	249.8319	253.6173	257.4026	261.1879
70	264.9733	268.7586	272.5439	276.3293	280.1146	283.8999	287.6853	291.4706	295.2559	299.0413
80	302.8266	306.6119	310.3972	314.1826	317.9679	321.7532	325.5386	329.3239	333.1092	336.8946
90	340.6799	344.4652	348.2506	352.0359	355.8212	359.6066	363.3919	367.1772	370.9626	374.7479
100	378.533									

NOTE: This table may be read from 100 to 1000 gallons in steps of 10 gallons by moving decimal points one place to right.

Figure 22c

NOMINAL ELEVATOR CAR SPEEDS IN
FEET PER MINUTE TO METERS PER MINUTE AND METERS PER SECOND

Feet per Min.	Meters per Min.	Meters per Sec.	Feet per Min.	Meters per Min.	Meters per Sec.	Feet per Min.	Meters per Min.	Meters per Sec.	Feet per Min.	Meters per Min.	Meters per Sec.	Feet per Min.	Meters per Min.	Meters per Sec.
5	1.5	.03	105	32.0	.53	205	62.4	1.04	325	99.0	1.65	425	129.0	2.16
10	3.0	.05	110	33.0	.56	210	64.0	1.07	350	107.0	1.78	450	137.0	2.29
15	4.6	.03	115	35.0	.58	215	65.0	1.09	375	114.0	1.91	475	145.0	2.41
20	6.0	.10	120	36.0	.61	220	67.0	1.12	400	122.0	2.03	500	152.0	2.54
25	8.0	.13	125	38.0	.64	225	68.0	1.14	425	129.0	2.16	550	168.0	2.79
30	9.0	.15	130	40.0	.66	230	70.0	1.17	450	137.0	2.29	575	175.0	2.92
35	11.0	.18	135	41.0	.69	235	71.0	1.19	475	145.0	2.41	600	183.0	3.05
40	12.0	.20	140	43.0	.71	240	73.0	1.22	525	160.0	2.67	625	190.0	3.18
45	14.0	.23	145	44.0	.74	245	74.0	1.24	550	168.0	2.79	650	198.0	3.30
50	15.0	.25	150	46.0	.76	250	76.0	1.27	575	175.0	2.92	675	205.0	3.43
55	17.0	.28	155	47.0	.79	255	78.0	1.30	600	183.0	3.05	700	213.0	3.56
60	18.0	.30	160	49.0	.81	260	79.0	1.32	625	190.0	3.18	725	221.0	3.68
65	20.0	.33	165	50.0	.84	265	80.0	1.35	650	198.0	3.30	750	229.0	3.81
70	21.0	.36	170	52.0	.86	270	82.0	1.37	675	205.0	3.43	775	236.0	3.94
75	23.0	.38	175	53.0	.89	275	84.0	1.40	700	213.0	3.56	800	244.0	4.06
80	24.0	.41	180	55.0	.91	280	85.0	1.42	725	221.0	3.68	825	251.0	4.19
85	26.0	.43	185	56.0	.94	285	87.0	1.45	750	229.0	3.81	850	259.0	4.32
90	27.0	.46	190	58.0	.97	290	88.0	1.47	775	236.0	3.94	875	267.0	4.45
95	29.0	.48	195	59.0	.99	295	90.0	1.50	800	244.0	4.06	900	274.0	4.57
100	30.0	.51	200	60.0	1.02	300	91.0	1.52	825	251.0	4.19	850	259.0	4.32

Figure 22d**FRACTIONS OF AN INCH (FOR EACH 64th) TO MILLIMETERS**

Fractions of Inch	64ths of Inch	Decimals	Millimeters
—	1	.015625	0.397
1/32	2	.031250	0.791
—	3	.046875	1.191
1/16	4	.062500	1.588
—	5	.078125	1.984
3/32	6	.093750	2.381
—	7	.109375	2.778
1/8	8	.125000	3.175
—	9	.140625	3.572
5/32	10	.156250	3.969
—	11	.171875	4.366
3/16	12	.187500	4.763
—	13	.203125	5.159
7/32	14	.218750	5.556
—	15	.234375	5.953
1/4	16	.250000	6.350
—	17	.265625	6.747
9/32	18	.281250	7.144
—	19	.296875	7.541
5/16	20	.312500	7.938
—	21	.328125	8.334
11/32	22	.343750	8.731
—	23	.359375	9.128
3/8	24	.375000	9.525
—	25	.390625	9.922
13/32	26	.406250	10.319
—	27	.421875	10.716
7/16	28	.437500	11.113
—	29	.453125	11.509
15/32	30	.468750	11.906
—	31	.484375	12.303
1/2	32	.500000	12.700

Figure 22d

FRACTIONS OF AN INCH (FOR EACH 64th) TO MILLIMETERS

Fractions of Inch	64ths of Inch	Decimals	Millimeters
—	33	.515625	13.097
17/32	34	.531250	13.494
—	35	.546875	13.891
9/16	36	.562500	14.288
—	37	.578125	14.684
19/32	38	.593750	15.081
—	39	.609375	15.478
5/8	40	.625000	15.875
—	41	.640625	16.272
21/32	42	.656250	16.669
—	43	.671875	17.066
11/16	44	.687500	17.463
—	45	.703125	17.859
23/32	46	.718750	18.256
—	47	.734375	18.653
3/4	48	.750000	19.050
—	49	.765625	19.447
25/32	50	.781250	19.844
—	51	.796875	20.241
13/16	52	.812500	20.638
—	53	.828125	21.034
27/32	54	.843750	21.431
—	55	.859375	21.828
7/8	56	.875000	22.225
—	57	.890625	22.622
29/32	58	.906250	23.019
—	59	.921875	23.416
15/16	60	.937500	23.813
—	61	.953125	24.209
31/32	62	.968750	24.606
—	63	.984375	25.003
1	64	1.000000	25.400

Figure 22e FEET TO METERS FROM 0 TO 249 FEET
(1 foot = 0.3048004006 meter)

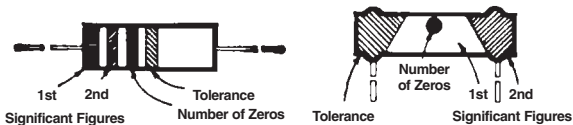
Feet	Meters	Feet	Meters	Feet	Meters	Feet	Meters	Feet	Meters
0	0.00000	50	15.24003	100	30.48006	150	45.72009	200	60.96012
1	.30480	1	15.54483	1	30.78436	1	46.02489	1	61.26492
2	.60960	2	15.84963	2	31.08966	2	46.32969	2	61.56972
3	.91440	3	16.15443	3	31.39446	3	46.63449	3	61.87452
4	1.21920	4	16.45923	4	31.69926	4	46.93929	4	62.17932
5	1.52400	5	16.76403	5	32.00406	5	47.24409	5	62.48412
6	1.82880	6	17.06883	6	32.30886	6	47.54889	6	62.78893
7	2.13360	7	17.37363	4	32.61367	7	47.85370	7	63.09373
8	2.43840	8	17.67844	8	32.91847	8	48.15850	8	63.39853
9	2.74320	9	17.98324	9	33.22327	9	48.46330	9	63.70333
10	3.04800	60	18.28804	110	33.52807	160	48.76810	210	64.00813
1	3.35281	1	18.59284	1	33.83287	1	49.07290	1	64.31293
2	3.65761	2	18.89764	2	34.13767	2	49.37770	2	64.61773
3	3.96241	3	19.20244	3	34.44247	3	49.68250	3	64.92253
4	4.26721	4	19.50724	4	34.74727	4	49.98730	4	65.22733
5	4.57201	5	19.81204	5	35.05207	5	50.29210	5	65.53213
6	4.87681	6	20.11684	6	35.35687	6	50.59690	6	65.83693
7	5.18161	7	20.42164	7	35.66167	7	50.90170	7	66.14173
8	5.48641	8	20.72644	8	35.96647	8	51.20650	8	66.44653
9	5.79121	9	21.03124	9	36.27127	9	51.51130	9	66.75133
20	6.09601	70	21.33604	120	36.57607	170	51.81610	220	67.05613
1	6.40081	1	21.64084	1	36.88087	1	52.12090	1	67.36093
2	6.70561	2	21.94564	2	37.18567	2	52.42570	2	67.66574
3	7.01041	3	22.25044	3	37.49047	3	52.73051	3	67.97054
4	7.31521	4	22.55524	4	37.79528	4	53.03531	4	68.27534
5	7.62002	5	22.86005	5	38.10008	5	53.34011	5	68.58014
6	7.92482	6	23.16485	6	38.40488	6	53.64491	6	68.88494
7	8.22962	7	23.46965	7	38.70968	7	53.94971	7	69.18974
8	8.53442	8	23.77445	8	39.01448	8	54.25451	8	69.49454
9	8.83922	9	24.07925	9	39.31928	9	54.55931	9	69.79934
30	9.14402	80	24.38405	130	39.62408	180	54.86411	230	70.10414
1	9.44882	1	24.68885	1	39.92888	1	55.16891	1	70.40894
2	9.75362	2	24.99365	2	40.23368	2	55.47371	2	70.71374
3	10.05842	3	25.29845	3	40.53848	3	55.77851	3	71.01854
4	10.36322	4	25.60325	4	40.84328	4	56.08331	4	71.32334
5	10.66802	5	25.90805	5	41.14808	5	56.38811	5	71.62814
6	10.97282	6	26.21285	6	41.45288	6	56.69291	6	71.93294
7	11.27762	7	26.51765	7	41.75768	7	56.99771	7	72.23774
8	11.58242	8	26.82245	8	42.06248	8	57.30251	8	72.54255
9	11.88722	9	27.12725	9	42.36728	9	57.60732	9	72.84735
40	12.19202	90	27.43205	140	42.67209	190	57.91212	240	73.15215
1	12.49682	1	27.73686	1	42.97689	1	58.21692	1	73.45695
2	12.80163	2	28.04166	2	43.28169	2	58.52172	2	73.76175
3	13.10643	3	28.34646	3	43.58649	3	58.82652	3	74.06655
4	13.41123	4	28.65126	4	43.89129	4	59.13132	4	74.37135
5	13.71603	5	28.95606	5	44.19609	5	59.43612	5	74.67615
6	14.02083	6	29.26086	6	44.50089	6	59.74092	6	74.98095
7	14.32563	7	29.56566	7	44.80569	7	60.04572	7	75.28575
8	14.63043	8	29.87046	8	45.11049	8	60.35052	8	75.59055
9	14.93523	9	30.17526	9	45.41529	9	60.65532	9	75.89535

1 inch = 0.02540 meter 4 inches = 0.10460 meter 7 inches = 0.17780 meter 10 inches = 0.25400 meter
 2 inches = 0.05080 meter 5 inches = 0.20320 meter 8 inches = 0.12700 meter 11 inches = 0.27960 meter
 3 inches = 0.07620 meter 6 inches = 0.15240 meter 9 inches = 0.22860 meter 12 inches = 0.30480 meter

22.2 Electrical

Figure 22f

COLOR CODE FOR FIXED RESISTORS – VALUES IN OHMS



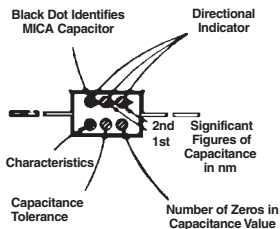
Resistor with axial wire leads.

Resistor with radial wire leads.

BODY		END		DOT OR BAND		END	
1st Band		2nd Band		3rd Band		End Band	
Color	Value	Color	Value	Color	Value	Color	Tolerance
Black	0	Black	0	Black	None	Gold	±5%
Brown	1	Brown	1	Brown	0	Silver	±10%
Red	2	Red	2	Red	00	None	±20%
Orange	3	Orange	3	Orange	000		
Yellow	4	Yellow	4	Yellow	0000		
Green	5	Green	5	Green	00000		
Blue	6	Blue	6	Blue	000000		
Violet	7	Violet	7	Violet	0000000		
Grey	8	Grey	8	Grey	00000000		
White	9	White	9	White	000000000		

Figure 22g

COLOR CODE FOR JAN FIXED MICA CAPACITORS

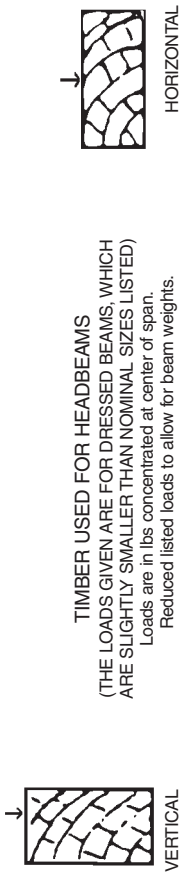


Color code scheme for JAN standard fixed mica capacitors. The significance of the letters denoting "characteristic" will be found in the joint Army-Navy Specification JAN-G-5.

Color	CAPACITANCE		Tolerance	Characteristic
	Significant Figure	Decimal Multiplier		
Black	0	1	20%(M)	A
Brown	1	10	B
Red	2	100	2%(G)	C
Orange	3	1,000	D
Yellow	4	E
Green	5	F
Blue	6	G
Violet	7
Grey	8
White	9
Gold	...	0.1	5%(J)	..
Silver	...	0.01	10%(K)	..

22.3 Timber, Beams and Planks

Figure 22h



SIZE (INCHES)	BEAM SPAN (FEET)										
	4	6	8	10	12	14	16	18	20	24	
4 x 4	990	660	500	390	330	280	280	330	370	455	570
4 x 6 Hor	1,530	1,000	750	600	500	430	430	500	570	690	780
4 x 6 Vert	2,280	1,520	1,140	910	760	650	650	770	860	940	1,070
6 x 6	3,460	2,310	1,730	1,380	1,150	990	990	1,170	1,290	1,290	1,460
6 x 8 Hor	4,710	3,140	2,360	1,880	1,570	1,340	1,340	1,610	1,750	1,750	1,940
6 x 8 Vert	6,400	4,290	3,220	2,580	2,150	1,840	1,840	2,200	2,430	2,430	2,780
8 x 8	8,540	5,870	4,400	3,520	2,930	2,510	2,510	3,000	3,300	3,300	3,740
8 x 12 Vert	12,820	8,270	6,030	4,820	4,000	3,400	3,400	4,100	4,500	4,500	5,100
8 x 14 Vert	14,920	9,500	7,000	5,500	4,500	3,900	3,900	4,700	5,100	5,100	5,800
8 x 16 Vert	17,070	10,700	7,900	6,200	5,100	4,400	4,400	5,300	5,700	5,700	6,500
10 x 10	13,330	8,930	6,700	5,300	4,400	3,800	3,800	4,600	5,000	5,000	5,700
10 x 12 Vert	16,000	10,400	7,800	6,200	5,100	4,400	4,400	5,300	5,700	5,700	6,500
10 x 14 Vert	18,660	12,100	9,000	7,100	5,800	5,000	5,000	6,000	6,500	6,500	7,500

*General Note: 1 in. = 25.4 mm; 1 ft = 0.305 m; 1 lb = 0.454 kg

Figure 22i

ALLOWABLE CONCENTRATED LOADS ON AMERICAN STANDARD BEAMS
LOAD IN CENTER OF SPAN WITH BEAM FIXED AGAINST HORIZONTAL MOVEMENT
LOAD IN KIPS (1,000 LBS.)

SPAN (FEET)	NOMINAL DEPTH & WIDTH – WEIGHT PER FEET													
	10 x 4-3/4		8 x 4		7 x 3-3/4		6 x 3-3/8		5 x 3		4 x 2-3/4		3 x 2-3/8	
	35	25.4	23	18.4	20	15.3	17.25	12.15	14.75	10	9.5	7.7	7.5	5.7
3	65		35		26			16	13	10	7	6	4	3
4	48		26	23	20	17	14	12	10	8	5	5	3	2
5	39	32	21	19	16	14	11	9	8	6	4	4	2	2
6	32	27	18	16	13	11	9	8	6	5	3	3	2	1
7	28	23	15	13	11	9	8	6	5	4	3	2	1	1
8	24	20	13	12	10	8	7	6	5	4	2	2		
9	21	18	12	10	8	7	6	5	4	3	2	2		
10	19	16	10	9	8	6	5	4	4	3				
11	17	15	9		7									
12	16													

*General Note: 1 in. = 25.4 mm; 1 ft = 0.305 m; 1 lb = 0.454 kg

Figure 22j

ALLOWABLE LOADS FOR WOOD PLANKS

(Pounds)

Total allowable uniformly distributed loads for timber planks supported at ends. The allowable concentrated load shall be one-half the distributed load.

Based on unit stress of 1,000 psi

Nom. Size (Inches) Actual Size (Inches)	PLANKS											
	6 x 2	8 x 2	10 x 2	12 x 2	14 x 2	8 x 3	7-1/2 x 2-5/8	13-1/2 x 1-5/8	11-1/2 x 1-5/8	10 x 3	12 x 3	
Area In. ²	9.15	12.20	15.45	18.70	21.95	19.70	25.0	21.95	18.70	19.70	25.0	30.2
Span (Feet)	410	550	700	850	990	1440	1820	990	850	1440	1820	2200
4	410	550	700	850	990	1440	1820	990	850	1440	1820	2200
5	330	440	560	680	790	1150	1460	790	680	1150	1460	1770
6	280	370	470	560	660	960	1220	660	560	960	1220	1470
7	240	320	400	480	570	820	1040	570	480	820	1040	1260
8	210	280	350	420	500	720	910	500	420	720	910	1100
9	180	250	310	380	440	640	810	440	380	640	810	980
10	220	280	340	400	580	730	400	340	580	730	880
11	200	250	310	360	520	660	360	310	520	660	800
12	180	230	280	330	480	610	330	280	480	610	740
13	220	260	310	440	560	310	260	440	560	680
14	200	240	280	410	520	280	240	410	520	630
15	180	210	250	360	460	250	210	360	460	590
16	200	240	340	430	240	200	340	430	550
17	190	220	320	400	220	190	320	400	520
18	210	300	380	210	300	380	490
19	200	290	370	200	290	370	460
20	440

*General Note: 1 in. = 25.4 mm; 1 ft = 0.305 m; 1 psi = 6.89 kPa; 1 in.² = 6.451 E-04 m²

Figure 22k

ALLOWABLE LOADS FOR BEAMS

(Pounds)

Allowable uniformly distributed loads for timber beams supported at ends. The allowable concentrated load shall be one-half (1/2) the distributed load.

Based on unit stress of 1,000 psi

Span (Feet)	BEAMS												
	2 x 4	2 x 6	2 x 8	2 x 10	2 x 12	2 x 14	4 x 4	4 x 6	4 x 8	4 x 10	4 x 12	6 x 6	
4	600	1430	2540	4070	5970	8230	1330	3190	4600				
5	480	1140	2030	3260	4780	6580	1060	2550	3690				
6	400	950	1700	2720	3980	5490	890	2120	3080				
7	340	820	1450	2320	3410	4700	760	1820	2630				
8	300	710	1270	2040	2990	4110	660	1590	2300				
9	1130	1810	2650	590	1420	2050				
10	570	1010	1630	2390	3290	530	1270	1840				
11	520	920	1480	2170	3000	480	1160	1670				
12	470	840	1360	1990	2740	440	1060	1530				
13	780	1250	1840	2530	980	1410				
14	720	1160	1710	2350	910	1310				
15	670	1090	1590	2190	850	1220				
16	630	1020	1490	2060	800	1150				
17	960	1400	1930	750	1080				
18	900	1320	1820	710	1020				
19	860	1260	1730	670	970				
20	810	1200	1640	640	930				
* Allowable Load for Shear at 100 lbs/in. ²	800	1230	1640	2080	2520	2950	1770	2740	4050				

*General Note: 1 in. = 25.4 mm; 1 ft = 0.305 m; 1 psi = 6.89 kPa; 1 in.² = 6.451 E-04 m²

INDEX

A

Acetylene Cylinders	132
Alcohol/Drug Use (Vehicle Safety)	158
Allowable Concentrated Loads on American Standard Beams (Chart).....	176
Allowable Loads for Beams (Chart)	178
Allowable Loads for Wood Planks (Chart)	177
Allowable Number of Broken Strands for Wire Ropes Used in Hoisting Equipment	87
Anchor, Safety Harness (Illustration).....	30
Asbestos (HAZCOM).....	140

B

Babbitting (HAZCOM)	138
Barricade (Illustration)	37
Batteries, Sulfuric Acid Type (HAZCOM)	142
Beam Clamps – Vertical Pull Only (Illustration)	85
Beam Clamps.....	119
Beams, Allowable Concentrated Loads on American Standard (Chart).....	176
Beams, Allowable Loads for (Chart)	178
Beams, Suspending Needle or Scaffolds (Illustration).....	94
Beams, Timber Used for	175
Blocking and Ramping of Material	82
Body Harness, Full (Illustration)	30

C

Cable Clips, Proper Methods of Installing	89
Cable Clips, Right and Wrong Ways of Using	89
Capacitors, Color Code for Jan Fixed MICA (Illustration) . . .	174
Carbon Dust (HAZCOM)	142
Cars, Temporary	72
Car-Top Safety	51
Chain Hoists	90
Chain Sling Capacities Lbs (Illustration).	104, 105
Chain Slings, Inspection of	100
Chemicals, Working With	134
Chisels, Use Only Properly Dressed (Illustration)	64
Chokers, Use of (Illustration)	94
Clamps, Beam	119
Cleaners (HAZCOM)	137
Clothing, Proper	22
Color Code for Fixed Resistors – Values in OHMS (Illustration)	173
Communication Devices (Vehicle Safety)	159
Competent Person	154
Crosby Lifting Guide	96
Cutting, Welding and	130

D

Driving and Vehicle Safety	158
Drug/Substance Abuse	160
Dumbwaiters	149

E

Electric, Portable Tools	64
Electrical Safety – General Precautions	39

Elevator Car Speeds in Ft/Min to M/M and M/S (Chart)	169
Elevator Maintenance Barricades	38
Employee Responsibilities	8
Endless Sling Assembly (Illustration)	91
Escalator/Moving Walk Barricades	37
Escalators and Moving Walks	146
Escalators and Moving Walks, Lockout Procedures for	50
Extension Cords, Approved Markings for	65
Eye and Face Protection	23, 153
Eye Bolts (Illustration)	94

F

Fall Arrest Equipment, Personal	26
Fall Protection	29
Fall-Arrest System, Personal	29
Falls, Five- Six- & Seven-Part (Illustration)	120,121
False Car (Illustration)	73
False Car with Optional Debris Net (Illustration)	74
False Cars and Other Devices Used in the Hoistway	72
Fastenings, Wire Rope	88
Filter Lens Shade Number for Protection Against Radiant Energy (Chart)	24
Fire, Precautions Against (Welding and Cutting)	130
Five-Part Falls (Illustration)	120, 121
Fixed Resistors, Color Code for (Values in OHMS) (Illustration)	173
Flammable Liquids and Solvents (HAZCOM)	141
Foot and Leg Protection	152
Foot Protection, Occupational	25
Fuel Gas Cylinders	132
Full-Body Harness (Illustration)	30

G

Gallons to Liters (Chart)	168
Glossary of Terms	161
Grease, Oils and (HAZCOM)	136
Guardrail Systems (Illustration).....	35, 36
Guardrail Systems	33

H

Hand Protection	27, 154
Hand Signals, Hoisting (Illustration)	92, 93
Hand Tools	63
Hardware, Rigging (Illustration)	109, 110, 111, 113
Harness, Full-Body (Illustration)	30
Hazard Communications (HAZCOM).....	134
Asbestos	140
Babbitting.....	138
Carbon Dust	142
Chemicals, Working with	134
Cleaners	137
Flammable Liquids and Solvents.....	141
Oils and Grease	136
Painting	139
Sulfuric Acid Type Batteries	142
Welding	140
Head Protection	25, 152
Headbeams, Timber Used for (Chart)	175
Hearing Protection	26, 152
Helpful Hints for On and Off the Job (Illustration)	80, 81
Hitches, Slings and.....	90
Hoisting and Rigging	82
Hoisting Structural Steel (Illustration)	95
Hoisting, Hand Signals (Illustration)	92, 93

Hoists, Chain	90
Hoistway Screening	60
Hoistway, False Cars and Other Devices Used in the Hoistway	72
Hoistways and Machine Rooms	51
Hook Slings (Illustration)	95

I

Inclined Elevators	145
Inspecting for Hazards	17
Inspecting Manila Rope (Illustration).....	123
Inspection, Safety Checklist.....	17
Inspections, Need for Routine Safety	17

J

Job Hazard Assessment, Service and Repair (Chart)	156, 157
Job Hazard Assessment, Service and Repair Job	151
Jumpers, Door Bypass Procedure	44
Jumpers, Maintenance and Troubleshooting	42
Jumpers, Modernization and New Construction	43
Jumpers, Proper Use of	41

K

Knots Are Weak	124
Knots: (Illustrations)	
Bowline on the Bight.....	127
Bowline	129
Carrick Bend	129
Catspaw.....	126

Clove Hitch (Builder's Hitch)	127
Figure Eight Follow Through	128
Figure Eight Knot	126
Figure Eight on a Bight	128
Reef Knot or Square Knot	126
Rolling Hitch	129
Round Turn and Two Half Hitches	128
Running Bowline	127
Sheepshank	129
Timber Hitch	126

L

Ladder, Proper Placement of (Illustration)	70
Ladders, Portable	68
Lens Shade Numbers, Filter (Chart)	24
Lifeline, Typical Top Anchorage of (Illustration)	29
Lifting Loads	78
Lifting, Positions for (Illustration)	79
Lights, Portable Electric	64
Liquids and Solvents, Flammable	141
Loads, Lifting	78
Lockout/Tagout (Illustration)	46
Lockout/Tagout Procedures for Escalators and Moving Walks	50
Lockout/Tagout Procedures	45
Lockout/Tagout, Supervisory/Emergency Removal	49

M

Machine Rooms, Hoistways and	51
Maintenance, Vehicle	159

Manila Rope Knots, Approximate Efficiency (Illustration)	125
Manila Rope	122
Manila Rope, Inspecting (Illustration)	123
Material Handling	78
Materials Handling – Ramping and Blocking of	82
Mechanic/Mechanic-In-Charge Responsibilities of	13
Moving Walks, Escalators and	146

O

Occupational Foot Protection	25
Occupational Head Protection	25
Oils and Grease (HAZCOM)	136
Overhead Protection	61
Oxygen Cylinders	132

P

Painting (HAZCOM)	139
Personal Fall Arrest Equipment	26
Personal Fall Arrest System	153
Personal Protective Equipment	22
Pit Safety	55
Planks, Allowable Loads for Wood (Chart)	177
Platforms, Running (Moving)	71
Platforms, Working	71
Portable Electric Tools and Lights	64
Portable Ladders	68
Pounds to Kilograms (Chart)	167
PPE Training	155
Pre-startup Safety Survey	19

R

Ramping and Blocking of Material	82
Resistors, Fixed Color Code for – Values in OHMS (Chart)	173
Respiratory Protection	27, 153
Rigging Hardware (Illustration)	109, 110, 111, 113
Rigging Plan, The Basic	98
Rigging Practices, Right and Wrong (Illustration)	94, 95
Rigging, Hoisting and	82
Rope Knots, Approximately Efficiency	125
Rope, Inspecting Manila (Illustration)	123
Rope, Manila	122
Running Platforms	71

S

Safety Belts (Vehicle Safety)	158
Safety Inspection Checklist	17
Safety Inspections, Need for Routine	17
Safety Responsibilities of the Mechanic/ Mechanic-In-Charge	13
Safety, Driving and Vehicle	158
Safety, Electrical – General Precautions	39
Scaffolds	67
Screening, Hoistway	60
Service and Repair Job Hazard Assessment (Chart)	156, 157
Service and Repair Job Hazard Assessment	151
Seven-Part Falls (Illustration)	120, 121
Signals, Hand Hoisting (Illustration)	92, 93
Six-Part Falls (Illustration)	120, 121
Sling Angles (Illustration)	108

Sling Capacities, Chain Lbs (Illustration)	104, 105
Sling Capacities, Web (Illustration)	106
Sling Capacities, Wire Rope Lbs. (Illustration)	101
Sling Capacities, Wire Rope Tons (Illustration).	102
Sling Loading, Center of Gravity (Illustration).	107
Sling Operating Practices	112
Slings and Connections to Fittings, Wire Rope	103
Slings and Hitches	90
Slings, Endless Assembly (Illustration).	91
Slings, Inspection of Chain	100
Slings, Inspection of Synthetic.	100
Slings, Inspection of Wire Rope	99
Slings, Synthetic Webbing	114
Soldering.	133
Solvents, Flammable Liquids and.	141
Structural Steel, Hoisting (Illustration).	95
Substance Abuse.	160
Sulfuric Acid Type Batteries (HAZCOM)	142
Suspending Needle Beams or Scaffolds (Illustration)	94
Synthetic Rope.	122
Synthetic Slings, Inspection of.	100
Synthetic Webbing Slings	114

T

Tagout Procedure, Lockout/.	45
Temporary Cars	72
Timber Used for Headbeams (Chart).	175
Tools, Hand.	63
Tools, Portable Electric.	64

V

Vehicle Maintenance	159
Vehicle Safety, Driving and	158
Vertical Pull Only – Beam Clamps (Illustration)	85

W

Web Sling Capacities (Illustration)	106
Welding (HAZCOM)	140
Welding, Cutting and Soldering	130
Wire Rope Deterioration	87
Wire Rope Sling Capacities Lbs. (Illustration)	101
Wire Rope Sling Capacities Tons (Illustration)	102
Wire Rope Slings and Connections to Fittings	103
Wire Rope Slings, Inspection of	99
Wire Ropes, Allowable Number of Broken Strands for Use in Hoisting Equipment	87
Wire Rope Failure, Causes of	87
Wire Rope Fastenings	88
Working Platforms	71
Workplace Hazards, Assessing	154

ELEVATOR WORLD

The Magazine of the International Building Transportation Industry

Digital Subscription ONLY \$25.00

Twelve monthly issues of ELEVATOR WORLD magazine e-mailed to your computer. This format offers enhanced features such as search a function, the ability to highlight text and electronic notes.

The Elevator World Source[®], the most complete international directory of industry manufacturers, suppliers, products, contractors, consultants and associations in digital format is included **FREE** with your subscription.

- **FREE Industry E-Mail Newsletter ELENET**[®]

(Register at www.elevator-world.com)

- **www.elevator-world.com**

- **News and information every business day**

- **Find-A-Part:** Get information on parts and services from the most well known and respected companies.

- **The Elevator World Source[®] Online:** Directory of industry manufacturers, suppliers, products, contractors, consultants and associations.

- **Message Board**

- **Books, videos, training materials and CD's**
(Subscribers receive 15% discount at www.elevatorbooks.com)

- **Research Center**

- **Classifieds**

- **www.theelevatormuseum.org**

- A virtual tour through elevator history

- Donate your historical pictures or knowledge

Elevator World, Inc.

E-mail: sales@elevator-world.com

Website: www.elevator-world.com

Phone: (251) 479-4514, Fax: (251) 479-7043

Free Safety Programs for Children and Adults



Safe-T Rider® teaches young children safety rules for riding on elevators, escalators and moving walks. An 8-minute video uses “rap” music and a little magic to show how to safely ride industry equipment. The classroom program contains one poster, video and guide, 25 each: activity book, sticker, certificate and test. Call EESF for your classroom package. Also, visit the interactive version at: www.safetrider.org

The Center for Education and Research in Safety evaluated the Safe-T-Rider program and confirmed that its use improved riding behavior of children by 42%. See complete report at [www. EESF.org](http://www.EESF.org)

A Safe Ride® is based on a stand-alone video and stand-alone printed materials. The video is aimed at the general public, while the safety workbooks target specific audiences, i.e., senior citizens, parents of young children, etc. Call EESF for materials.



Also, visit the interactive version at: www.asaferide.org

Elevator Escalator Safety Foundation
362 Pinehill Drive
Mobile, AL 36606

(251) 479-2199
E-mail: info@eesf.org
Website: www.eesf.org